

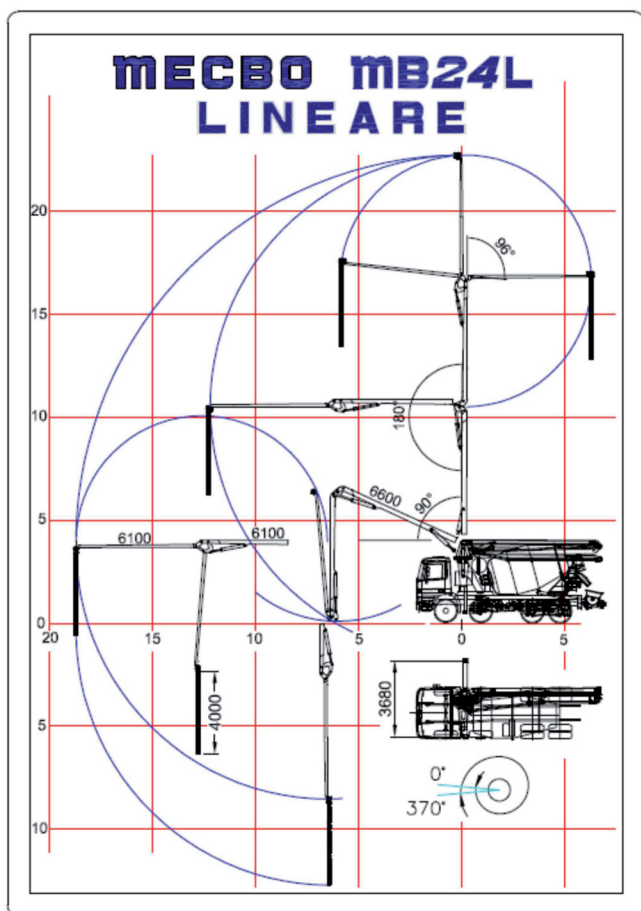

m e c b o



ATB24 LINEARE

Sistema Peristaltico - Peristaltic System- Système Péristaltique Peristaltic System - Sistema peristatico

PULSAR R60 - Scarrabile







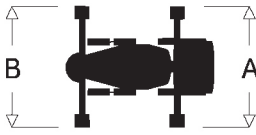

Portata Volumetrica	Volumetric output	Débit	Fordermenge	Capacidad de salida	55-60m ³ /h
Pressione Uscita	Pressare	Working pressure	Betondruck	Presion de salida	25 Bar
Sistema idraulico "Scarrabile"	Dismountable hydraulic system	Système hydraul. "démontable"	Abnehmbares Hydrauliksystem	Sistema hidraulico desmontable	

Braccio - Boom - Flèche Mast - Brazo MECBO M24L / 100-BZ LINEARE

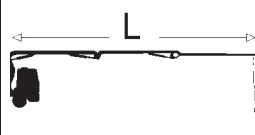
N° elementi movimentazione	Number of sections movement	N° éléments movimentation	Anzahl der Arme	N° de tramos movimiento	3 Z
Rotazione torretta	Tower rotation	Rotation tourelle	Drehbewegung Mast	Rotacion de la torreta	370°
Altezza massima	Max height	Hauteur max	Max Hohe	Altura max	24 m
Larghezza stabilizz. (Anteriore)	Front outriggers width	Largeur stabilisateurs (avant)	Weite der vorderen Abstützung	Anchura estabilizadores anteriores	3,9 m
Altezza minima di apertura	Min. opening height	Hauteur minimale d'ouverture	Mind. Ausfaltheöhe	Altura minima de apertura	6,27 m
Tubazione di mandata	Concrete Pipeline Diameter	Tuyauterie à béton	Rohrdurchmesser	Tuberia de envío	4" = 100 mm

Betoniera - Mixer - Malaxeur Mischer - Hormigonera

Capacità con PULSAR R60 montato	Capacity with PULSAR R60 mounted	Capacité avec PULSAR R60 montée	Volumen mit PULSAR R60 montiert	Capacidad con PULSAR R60 montado	7 m ³
Capacità con PULSAR R60 Scarrato	Capacity with PULSAR R60 Dismounted	Capacité avec PULSAR R60 démontée	Volumen mit PULSAR R60 abmontiert	Capacidad con PULSAR R60 desmontado	8 m ³
Autotelaio	Truck	Camion	Lkw	Camion	8x4

Tipo, Type Type, Typ Modelo	Altezza (m) Height Hauteure Höhe Altura				
ATB24 LINEARE	24	A (m) 3,9	Hmin (m) 6,27	L (m) 20,1	
		B (m) 0			
ATB26	26	A (m) 4,00	Hmin (m) 7,35	L (m) 22,0	
		B (m) 2,30			
ATB29	29	A (m) 5,10	Hmin (m) 6,50	L (m) 25,0	
		B (m) 2,25			
ATB30	30	A (m) 4,00	Hmin (m) 6,80	L (m) 26,0	
		B (m) 3,60			

Pompa a Pistoni Piston Pump Pompe à Piston Kolbenpumpe Bomba de pistones	ØCanne/Corsa ØCylind/Stroke ØCylind./Course ØZylind./Hub ØCilindros/Carrera	Portata (m ³ /h) Output Débit Fördermenge Capacidad	Cicli / 1' Cycles/1' Cycles/1' Hübe/1' Ciclos	Pressione (bar) Pressure Pression Betondruck Presión (bares)	
PULSAR 4	180/1000	40	26	50	
PULSAR 6	200/1000	60	31	50	

Pompa Peristalt. Peristalt. Pump Pompe Peristalt. Rotorpumpe Bomba peristatica	Portata (m ³ /h) Output Débit Fördermenge Capacidad	Tramoggia (l) Hopper Tremie Trichter Tolva	Pressione (bar) Pressure Pression Betondruck Presión (bares)	
PULSAR RS	60	350	26	

Pompa a Pistoni Piston Pump Pompe à Piston Kolbenpumpe Bomba de pistones	Portata (m ³ /h) Output Débit Fördermenge Capacidad	Pressione (bar) Pressure Pression Betondruck Presión (bares)	Peso solo pompa (kg) Core pump wight Poids du pompe Gewicht pompe Peso de la boma	
ATB P2.800	15	50	900	

I presenti dati hanno valore indicativo. Con l'evolversi della tecnologia, i dati esposti potranno subire modifiche senza preavviso. Le richieste tecniche specifiche debbono essere sempre accettate dalla nostra Direzione con conferma scritta.
The present technical data have indicative value. Owing to the technology development, all above mentioned details may be changed without any notice. All specific technical requests must be always accepted from our Management by written confirmation.
Les présents donnés ont valeur indicatif. Avec l'évolution de la technologie, les détails mentionnés pourront être modifiés sans aucun avis. Toutes les demandes techniques spécifiques doivent être toujours acceptées par notre Direction avec confirmation écrite.
Die aufgeführten technischen Daten, dienen ausschließlich dem Vergleich. Unsere Technologie wird ständig weiterentwickelt. Wir behalten uns jederzeit vor, die Daten jederzeit ohne Information zu ändern. Alle technischen Anfragen oder Änderungen müssen immer von unserer Firmenleitung schriftlich bestätigt werden.
Los datos técnicos indicados tienen valor indicativo. Los datos indicados podran cambiar sin preaviso de fabrica, debido a la continua evolucion de la tecnologia. Nuestra dirección técnica suministrara siempre los exactos detalles técnicos por escrito.

MECBO

Sede e Stabilimento:
Via Umbria, 8/12 - 40024 Osteria Grande (Bo) - ITALY
Tel. 051.945085 - 051.946119 - Fax 051.945220
Servizio Ricambi Tel. 051.946485 - www.mecbo.it
E-mail: info@mecbo.it
P.IVA 00508751203 - C.F. 00418580379
Reg. Imprese Bologna 19791

