

180W BATTERY-OPERATED MODULAR SOUND SYSTEM

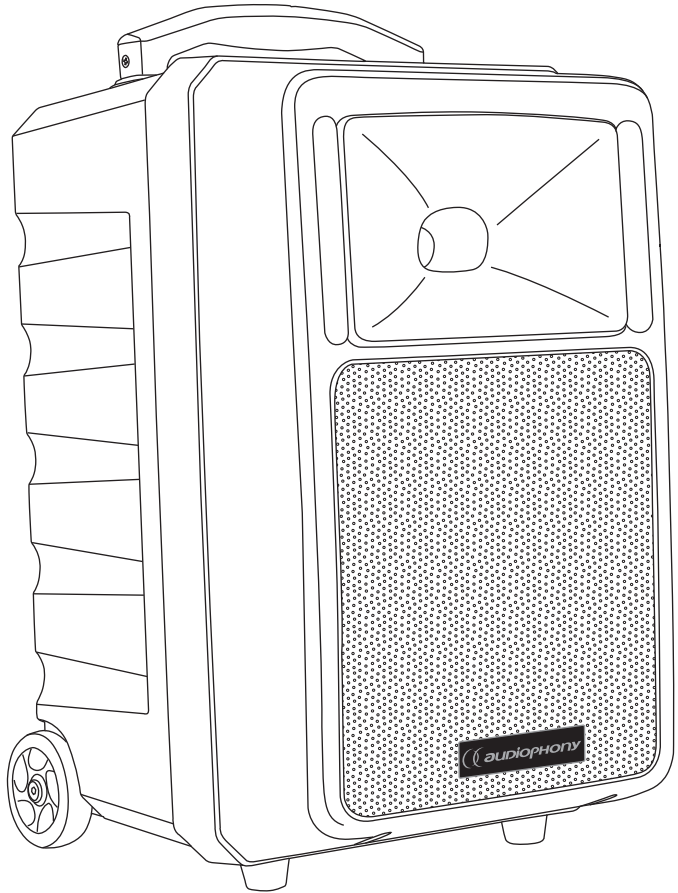

CROSSER SYSTEMS

9978 : CROSSER-One-V180

9895 : CROSSER-180

9984 : PASSCROSS

9982 : USB-RUN

9993 : CD-RUN

9980 : EMET-HAND

9981 : EMET-HEAD

9979 : RECEPT-MOD16

9985 : COV-CROSS

USER GUIDE

December 2012 Version 1.0

1 - Safety information

Important safety information



This unit is intended for indoor use only. Do not use it in a wet, or extremely cold/hot locations. Failure to follow these safety instructions could result in fire, electric shock, injury, or damage to this product or other property.



This product contains non-isolated electrical components. Do not undertake any maintenance operation when it is switched on as it may result in electric shock.



Any maintenance procedure must be performed by a CONTEST authorised technical service. Basic cleaning operations must thoroughly follow our safety instructions.



CAUTION
RISK OF ELECTRIC SHOCK
DO NOT OPEN



WARNING : This unit contains no user-serviceable parts. Do not open the housing or attempt any maintenance by yourself. In the unlikely even your unit may require service, please contact your nearest dealer. In order to avoid any electrical malfunction, please do not use any multi-socket, power cord extension or connecting system without making sure they are perfectly isolated and present no defect.



Risk of electrocution

To prevent the hazard of electric shocks, do not use extension cords, multi-socket or any other connection system without making sure metal parts completely are out of reach.



Sound levels

Our audio solutions deliver important sound pressure levels (SPL) that can be harmful to human health when exposed during long periods. Please do not stay in close proximity of operating speakers.



Recycling your device

- As HITMUSIC is really involved in the environmental cause, we only commercialise clean, ROHS compliant products.
- When this product reaches its end of life, take it to a collection point designated by local authorities. The separate collection and recycling of your product at the time of disposal will help conserve natural resources and ensure that it is recycled in a manner that protects human health and the environment.

Symbols used



This symbol signals an important safety precaution.



The CAUTION symbol signals a risk of product deterioration.



The WARNING symbol signals a risk to the user's physical integrity. The product may also be damaged.

Instructions and recommendations

1 - Please read carefully :

We strongly recommend to read carefully and understand the safety instructions before attempting to operate this unit.

2 - Please keep this manual :

We strongly recommend to keep this manual with the unit for future reference.

3 - Operate carefully this product :

We strongly recommend to take into consideration every safety instruction.

4 - Follow the instructions:

Please carefully follow each safety instruction to avoid any physical harm or property damage.

5 - Avoid water and wet locations :

Do not use this product in rain, or near washbasins or other wet locations.

6 - Installation :



We strongly encourage you to only use a fixation system or support recommended by the manufacturer or supplied with this product. Carefully follow the installation instructions and use the adequate tools.

Always ensure this unit is firmly fixed to avoid vibration and slipping while operating as it may result in physical injury.

7 - Ceiling or wall installation :

Please contact your local dealer before attempting any ceiling or wall installation.

8 - Ventilation :



The cooling vents ensure a safe use of this product, and avoid any overheating risk.

Do not obstruct or cover these vents as it may result in overheating and potential physical injury or product damage. This product should never be operated in a closed non-ventilated area such as a flight case or a rack, unless cooling vents are provided for the purpose .

9 - Heat exposure :

Sustained contact or proximity with warm surfaces may cause overheating and product damages. Please keep this product away from any heat source such as a heaters, amplifiers, hot plates, etc...

10 - Electric power supply :

This product can only be operated according to a very specific voltage. These information are specified on the label located at the rear of the product.

11 - Power cords protection:

Power-supply cords should be routed so that they are not likely to be walked on or pinched by items placed upon or against them, paying particular attention to cords at lugs, convenience receptacles and the point where they exit from the fixture.



12 - Cleaning precautions :



Unplug the product before attempting any cleaning operation. This product should be cleaned only with accessories recommended by the manufacturer. Use a damp cloth to clean the surface. Do not wash this product.

13 - Long periods of non use :

Disconnect the unit's main power during long periods of non use.

14 - Liquids or objects penetration :

Do not let any object penetrate this product as it may result in electric shock or fire.

Never spill any liquid on this product as it may infiltrate the electronic components and result in electric shock or fire.

15 - This product should be serviced when :



Please contact the qualified service personnel if :

- The power cord or the plug has been damaged.
- Objects have fallen or liquid has been spilled into the appliance.

- The appliance has been exposed to rain or water.
- The product does not appear to operate normally.
- The product has been damaged.

16 - Inspection/maintenance :



Please do not attempt any inspection or maintenance by yourself. Refer all servicing to qualified personnel.

17 - Operating environment :



Ambient temperature and humidity: +5 - +35°C, relative humidity must be less than 85% (when cooling vents are not obstructed).

Do not operate this product in a non-ventilated, very humid or warm place.

2 - Introduction

Thank you for purchasing a CROSSER series product.
The CROSSER series was designed around a battery-operated amplified system delivering 180W of high-quality sound.
Many options are available to allow everyone to build the perfect sound system.

This user guide will allow you to understand and use all the functions of the your system.
Please keep it within reach during the first uses in order to get familiar with the unit.

Main features of the CROSSER series

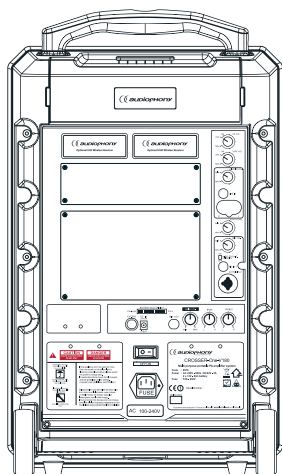

CROSSER-One-V180

This is the perfect product to start from scratch and build your portable sound system a la carte. It only features an amplified speaker, the rest is up to you: two wired microphone, a CD player, USB or MP3 player.

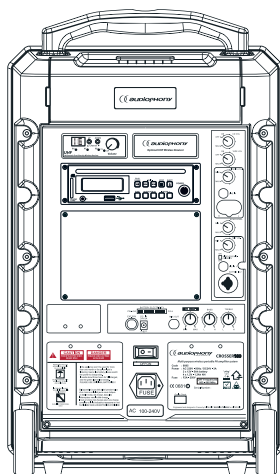

CROSSER-180

It features the essential components of a mobile sound system:

- 180W amplified speaker
- CD/USB player
- HF system with handheld microphone and receiver

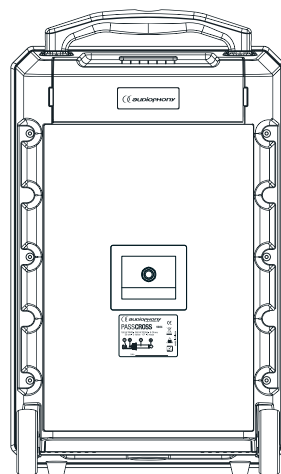

PASSCROSS

The passive version of the CROSSER. It allows you to increase the sound diffusion of your system.

3 - Description of the CROSSER

- 1 - Telescopic transport handle
- 2 - Control panel
- 3 - Façade including the protection grille, loudspeakers and front infrared sensor.
- 4 - A : 1.5 inches titanium driver / B : 10 inches neodymium boomer
- 5 - Wheels
- 6 - Protection grille
- 7 - 35 mm mounting plate for speaker stands

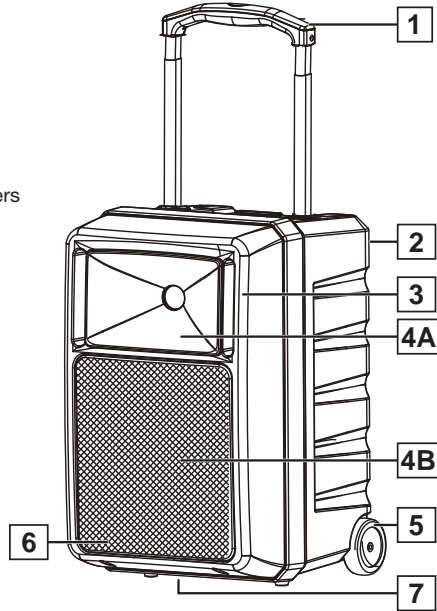

4 - The modules

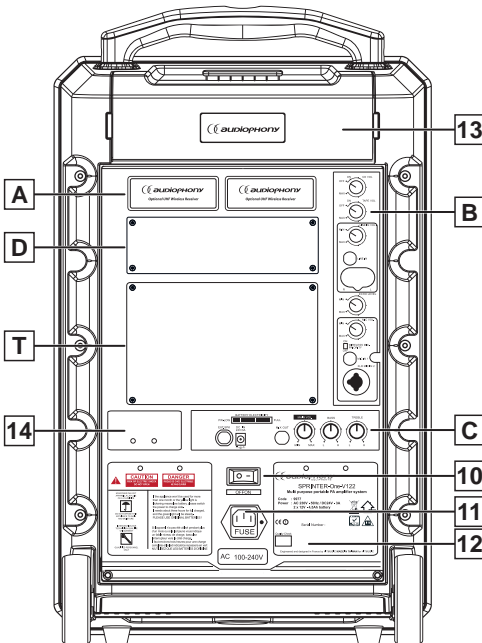

- 10 - Power switch
- 11 - Power input socket: 100-240V 50-60Hz
- 12 - Battery access hatch
- 13 - Accessories compartment hatch.
- 14 - UHF microphone batteries charger
- A - Modules for UHF receivers: 2 modules
- B - Volume control zone
- C - Main control zone
- D - Module for CD/USB (CD-RUN) player or USB (USB-RUN) reader
- T - Optional cassette player modules

NOTE : The receiver and reading modules only are amovible. The controle zones are built-in and cannot be removed.

5 - Description of the modules

5-1 : Description of the volume control zone (B)

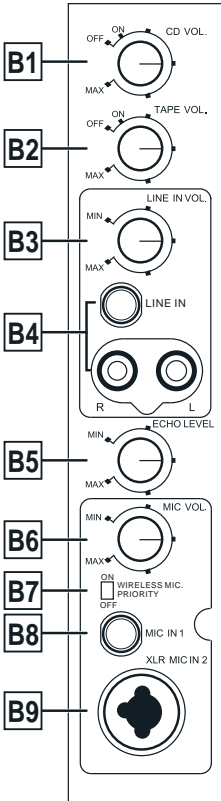

- B1** - CD or USB player volume control fader. From OFF to max (clockwise).
- B2** - Cassette player volume control fader. From OFF to max (clockwise).
- B3** - LINE IN volume control fader. From minimum to maximum (clockwise).
- B4** - Line-level LINE IN external input via RCA socket.
- B5** - Echo volume control fader. From minimum to maximum (clockwise).
- B6** - MIC 1 and 2 volume control fader. From minimum to maximum (clockwise).
- B7** - Activation button for the WIRELESS PRIORITY (Talkover) function. This function affects all the microphone inputs (Wired and UHF).
- B8** - Jack 6.35 microphone input.
- B9** - Combo XLR / Jack 6.35 microphone input.

5-2 : Description of the main control zone (C)

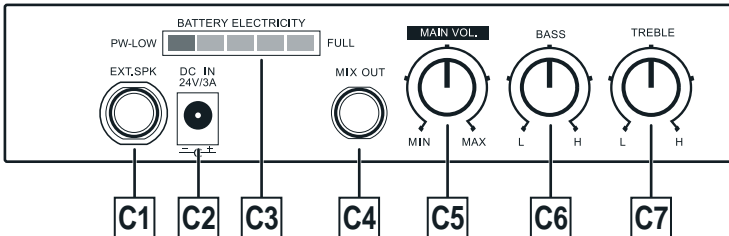

- C1** - Connector for an extra speaker (PASSPRINT - 120W 10" speaker).
CAUTION: 8 Ohms speakers only
- C2** - Connector for external adapter: 24V, DC 3A.
- C3** - Battery charge level indicator.
- C4** - Line output: allows you to retrieve the CROSSER signal, including the mic (UHF and wired) and CD player.
- C5** - Main volume control fader. From minimum to maximum (clockwise).
- C6** - Bass control fader. From Low to High (clockwise).
- C7** - Treble control fader. From Low to High (clockwise).



5-3 : Description of one of the UHF receiver module (A = RECEPT-MOD16)

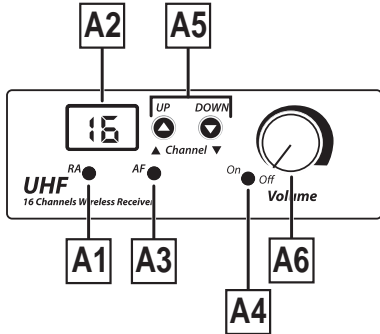

- A1** - Radio Frequency indicator: indicates if the microphone is activated. The indicator flashes when the mic is ON.
- A2** - Displays the current frequency.
- A3** - Audio Frequency indicator: indicates if the transmitter is emitting a signal.
- A4** - ON/OFF Indicator: indicates if the module is activated.
- A5** - Channel selector: allows you to choose one of the 16 frequencies available.
- A6** - HF module volume control fader: From OFF to maximum (clockwise).

5-4 : Description of the UHF handheld microphone (EMET-HAND)

- H1** - Grille : Protects the capsule.
- H2** - Capsule: converts the sound pressure into a signal.
- H3** - Lockring.
- H4** - Battery charge level indicator. Flashes then stays lit when the batteries are empty.
- H5** - ON/OFF power switch.
- H6** - Channel selector, position it on the same channel as the RECEPT-MOD16 receiver.
- H7** - Compartment for 2 LR06 batteries. Please make sure to keep the same polarities during battery changes.

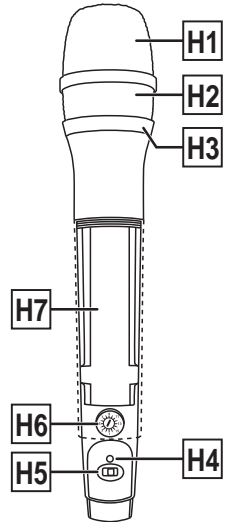

5-5 : Description of the headband mic/transmitter system (EMET-HEAD)

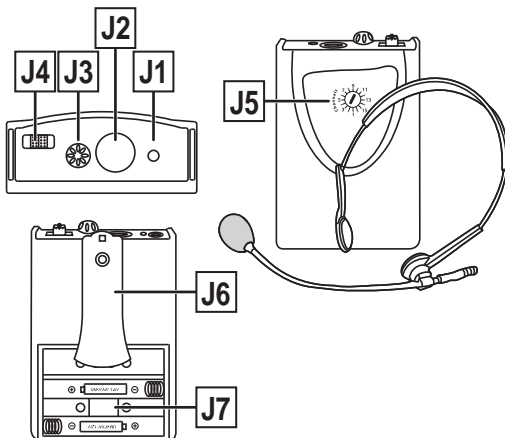

- J1** - Battery charge level indicator. Flashes then stays lit when the batteries are empty.
- J2** - Mini XLR socket to connect the wired microphone, hardwired as follows:
 - Signal: pins 2 and 3
 - Mass: pin 1
- J3** - Volume control fader. From low to high (clockwise).
- J4** - ON/OFF power switch.
- J5** - Channel selector, position it on the same channel as the RECEPT-MOD16 receiver.
- J6** - Belt clip.
- J7** - Battery compartment. Please make sure to keep the same polarities during battery changes (type LR06 1.5V)

5-6 : Description of the CD/USB (CD-RUN) player

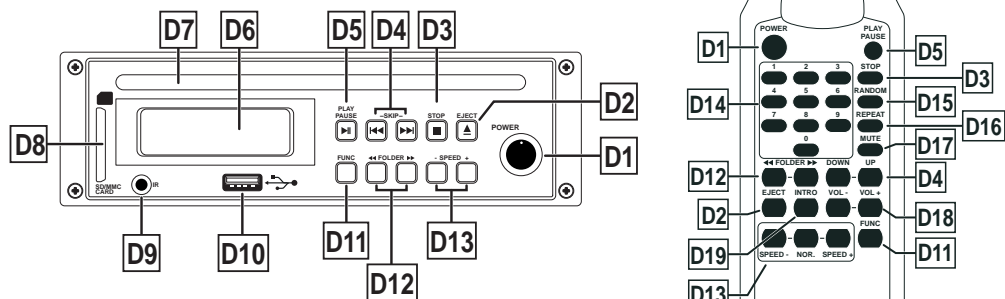

- D1 - POWER:** Turns the player ON.
- D2 - EJECT:** Ejects the CD.
- D3 - STOP:** Stops the current track (CD/USB/SD).
- D4 - SKIP:** Jumps from one track to another (CD/SD/USB).
- D5 - PLAY/PAUSE:** Plays or pauses the current track.
- D6 - DISPLAY:** Backlit LCD display.
- D7 - CD SLOT:** Insert your CD here.
- D8 - SD SLOT:** Insert your SD card here.
- D9 - REMOTE:** Infrared sensor for the remote control.
- D10 - USB slot:** Connect your USB or HDD here.
- D11 - FUNC:** Selects the source (USB, CD or SD).
- D12 - FOLDER:** Allows you to browse through the folders of your USB, CD or SD support.
- D13 - SPEED buttons:** Modify the playback speed.
PITCH -: Slows down the playback speed (5 different levels).
PITCH +: Speeds up the playback speed (5 different levels).
NOR. (Remote control only): Goes back to default speed.

- D14 - 0 - 9 buttons** (Remote control only): Allows you to directly reach a track. Use several buttons to reach tracks beyond number 9.
- D15 - RANDOM** (Remote control only): Allows you to activate the random playback mode. Use the **SKIP** button to move onto the next track.
- D16 - REPEAT** (Remote control only): repeats a track: **REP ONE**, the whole CD: **REP ALL**, or the whole folder: **REP FOLDER**.
- D17 - MUTE** (Remote control only): interrupts the audio output.
- D18 - VOL-/VOL+** (Remote control only): Increases or decreases the volume of the player.
- D19 - INTRO** (Remote control only): Allows you to play the 10 first seconds of each track of the CD or current folder.

5-7 : Description of the USB player (USB-RUN)

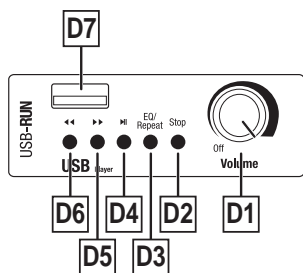

- D1 - Volume control fader:** From OFF to maximum (clockwise).
- D2 - Stop button:** Stops the playback and goes back to the beginning of the track.
- D3 - EQ/Repeat Button:**
 - Allows you to choose one of the 7 preset equalization modes: NORMAL/POP/ROCK/JAZZ/CLASSICAL/COUNTRY.
 - Press and hold for 3 seconds to choose one of the 3 preset repeat modes: OFF/SINGLE/ONE/FOLDER ALL/RANDOM.
- D4 - Play/Pause Button:** Stops or resumes the track.
- D5 - Skip Forward Button:** Skips to the next track.
- D6 - Skip Backward Button:** Goes back to the previous track.
- D7 - USB port:** Connect your USB support (key, HDD...) here.

NOTE: If your USB device contains several folders, the USB-RUN does not make any difference between the folders and will read all of them (depending on the Repeat mode chosen -D3).

6 - Power management

6 - 1 : Description of the power management system

1 - Indicators: They indicate the charge level from FULL to LOW. **PW** indicates the RUNNER is active. You must change the battery as quickly as possible when the **LOW** indicator is lit.

2 - DC Input: Allows you to connect an external DC power supply unit (24V 2.5A). Please respect the polarity (+ in the middle).

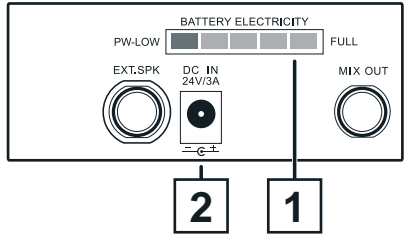

Note about batteries:

Please use the original battery. If need to replace the battery, use a model with the same characteristics. Please charge the batteries before using them for the first time. The RUNNER is designed to charge two batteries at a time. In order to preserve the batteries, turn the device off when you are not using it. The battery can be severely damaged if it is totally emptied by an inactive system.



Moreover, the batteries must be regularly recharged to prevent it from drying. The batteries are considered wearing parts and are not covered by the warranty.

6 - 2 : Replacing the CROSSER batteries

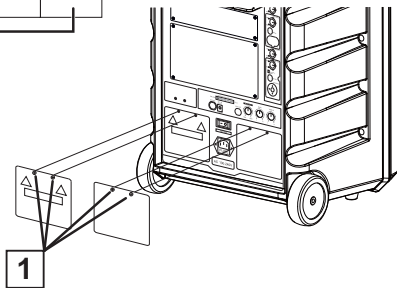
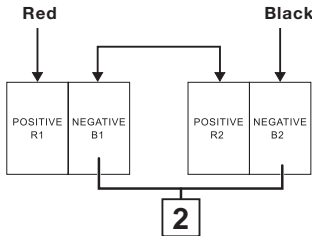

- 1 - Turn OFF your CROSSER.
- 2 - Open the rear access hatch as described on Figure 1.
- 3 - Remove the used batteries.
- 4 - Install the new batteries in their compartment.
- 5 - Position the batteries as described on Figure 2.
- 6 - Make sure the battery is in position and close the hatch.

Notes :

- Caution: Please make sure to position the batteries properly, as described on Figure 2, as your device can be damaged by an improper positioning.
- New batteries must be fully recharged before being used. The green indicator flashes during the charging process and the **FULL** indicator remains lit when the battery is fully charged.

6 - 3 : Precautions and recommendations concerning the batteries

- 1 - This device features a 12 V / 5 Ah battery allowing an average battery life of 7 hours.
- 2 - The complete charging process duration is approximately 9 hours.
- 3 - A built-in power management system indicates if the battery needs to be charged.
- 4 - If the battery level gets too low, the «**LOW**» indicator alone will light up, please plug your unit to an electrical outlet or replace the batteries.
- 5 - Used batteries must be taken care of properly. Do not dispose of them in the environment.
- 6 - In order to preserve the battery, please completely turn off your device when not using it.
- 7 - We strongly recommend to remove the battery during long periods of non-use.
- 8 - The battery must be charged regularly to prevent it from drying and becoming unusable.
- 9 - The battery is considered as wearing part and is not covered by the warranty.

7 - Spare parts and accessories

7 - 1 : Transducers





CRW10-180
Loudspeakers :
180 W - 8 Ω
10"



CRDR-20
30W 1.5" driver

7 - 2 : Optional accessories and modules for CROSSER systems

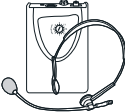
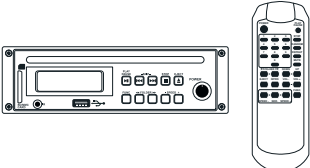
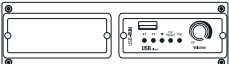
	<p>RECEPT-MOD16 UHF receiver module with 16 frequencies To be used with EMET-HAND and EMET-HEAD</p>
	<p>EMET-HAND Handheld UHF microphone with 16 frequencies To be used with the RECEPT-MOD16</p>
	<p>EMET-HEAD Headband UHF microphone and bodypack transmitter with 16 frequencies To be used with the RECEPT-MOD16</p>
	<p>CD-RUN CD player with USB input and infrared remote control</p>
	<p>USB-RUN USB player for MP3 files</p>

8 - Technical specifications

	CROSSER-180	CROSSER-One-V180
Loudspeakers	10" 4 Ohms neodymium loudspeaker + 1.5" 8 Ohms titanium driver	10" 4 Ohms neodymium loudspeaker + 1.5" 8 Ohms titanium driver
Power	Class D + AB 180W RMS amplifier / 250W max.	Class D + AB 180W RMS amplifier / 250W max.
UHF microphone	UHF with 16 frequencies available	Optional
Frequency range	UHF 863-865 Mhz	UHF 863-865 Mhz if an optional UHF module is installed
Players	CD MP3 player with anti-shock system, USB/SD reader with pitch control. Supplied with an infrared remote control.	Optional
Autonomy	3 to 7 hours depending on the volume	3 to 7 hours depending on the volume
Recharge time	9 hours for both 12V batteries 4 hours for the microphone batteries	9 hours for both 12V batteries
Batteries	2 x 12V / 5Ah NP for the system. 4x 1.2V / 1.3 Ah NH for the microphone	2 x 12V / 5Ah NP for the system
Power management	Visualise the charge level via LED display. Charge it and use it simultaneously. Automatic shutdown in case of low battery level.	Visualise the charge level via LED display. Charge it and use it simultaneously. Automatic shutdown in case of low battery level.
Settings	CD, Volume, Line in volume, Mic volume, talkover, Main volume, Medium and bass control	CD, Volume, Cassette volume, Line in volume, Mic volume, talkover, Main volume, Medium and bass control
Accessories	Storage compartment for two microphones or bodypack transmitter. Built-in 1.2V battery charger. Retractable handle and transport wheels. Supplied with protective cover.	Storage compartment for two microphones or bodypack transmitter. Built-in 1.2V battery charger. Retractable handle and transport wheels. Supplied with protective cover.
Finish	Polypropylene speaker, steel grille. 3/8" microphone mounting plate.	Polypropylene speaker, steel grille. 3/8" microphone mounting plate.
Dimensions in mm	500 x 320 x 360	500 x 320 x 360
Net weight incl. batteries	17 kg	16 kg

Because AUDIOPHONY® takes the utmost care in its products to make sure you only get the best possible quality, our products are subjects to modifications without prior notice. That is why technical specifications and the products physical configuration might differ from the illustrations.

Make sure you get the latest news and updates about the AUDIOPHONY® products on www.audiophony.com
AUDIOPHONY® is a trademark of HITMUSIC S.A. - Zone Cahors sud - 46230 FONTANES - FRANCE