

# N 952 SERIES VACUUM PUMPS

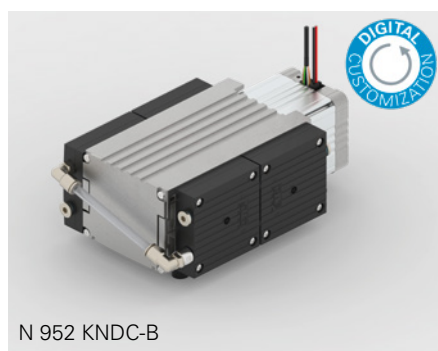

N 952 KNDC-B



N 952 KTE-W



N 952 KT.29 E-W

## ADVANTAGES

- High-speed evacuation for deep ultimate vacuum
- Excellent vibration and noise behavior
- Stable vacuum generation even at different speeds
- Digital parametrization allows speed control, the exact mapping of specific start-up characteristics, a dynamic operating profile and safety patterns

## POSSIBLE AREAS OF USE

- Can be used as roughing pump for turbomolecular pumps
- Instrumental analysis – especially in the field of spectroscopy

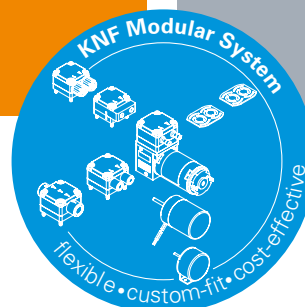

Please visit our website  
[www.knf.com](http://www.knf.com)  
to get more information

PERFORMANCE DATA			
Series model	N 952		
Material design	KNDC-B	KTE-W	KT.29 E-W
Pump head	PPS	PPS	
Diaphragm	EPDM	PTFE-coated	
Valves	FPM	FPM	
Flow rate at atm. pressure (l/min)	11 – 36	32	9 – 32
Suction speed (m <sup>3</sup> /h)	0.66 – 2.16	1.92	0.54 – 1.92
Ultimate vacuum (mbar abs.)	1.5	2	
Max. operating pressure (bar rel./psig)	0.1 / 1.4	0.1 / 1.4	
Permissible ambient temperature (°C)	+5 ... +40	+5 ... +40	
Permissible media temperature (°C)	+5 ... +40	+5 ... +40	
Weight (kg/lbs)	4.8 / 10.6	6.8 / 14.9	
ELECTRICAL DATA			
Voltage (V)	24	100 – 240	100 – 240
Motor	Brushless DC motor	Brushless DC motor with AC power supply	
Protection class motor	IP 20	IP 20	
Frequencies (Hz)	-	50 / 60	50 / 60
Power P <sub>1</sub> (kW)	0.1	0.1	0.1
I (A)	4.2	1 – 0.6	1 – 0.6

# N 952 KNDC-B

## PERFORMANCE DATA

Material design	Flow rate at atm. pressure (l/min) <sup>1</sup>	Max. operating pressure (bar rel./psig)	Ultimate vacuum (mbar abs.)
N 952 KNDC-B	11–36	0.1/1.4	1.5

<sup>1</sup>Flow rate determined at 20 °C, 1000 mbar abs.  
(Pressure 0 to 1000 mbar abs. in accordance with ISO 21360 / ISO 8778)

## N 952 KNDC-B

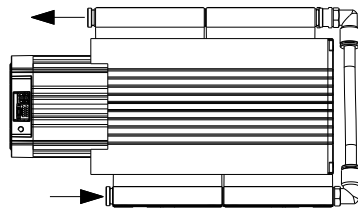
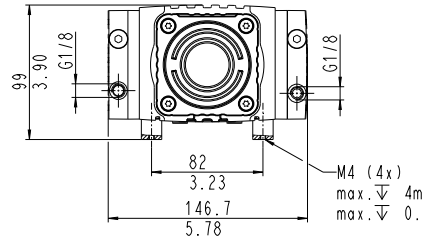
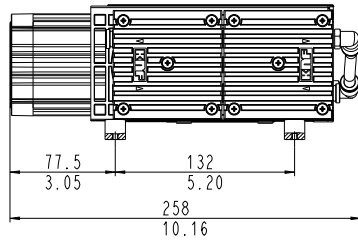

mm  
in

## N 952 KNDC-B

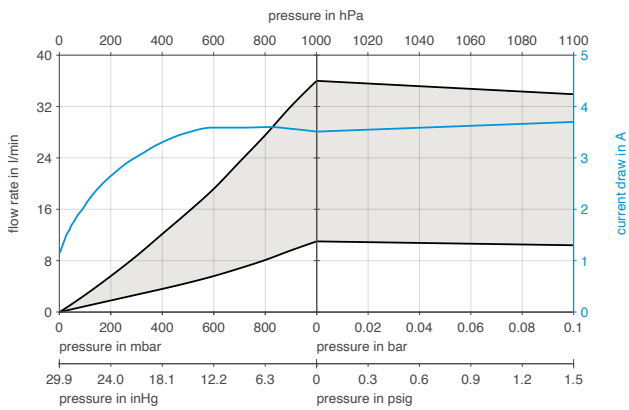

## N 952 KNDC-B | SUCTION SPEED

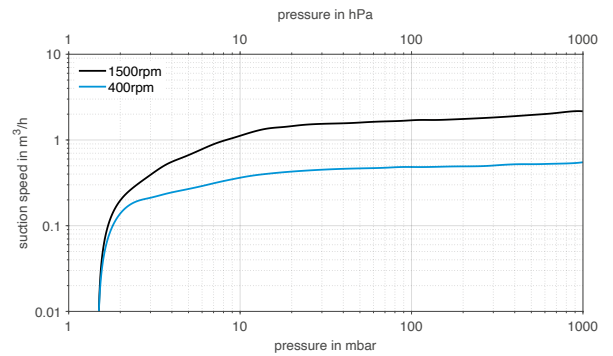

## N 952 KNDC-B | PUMP DOWNTIME FOR 10 LITER VESSEL

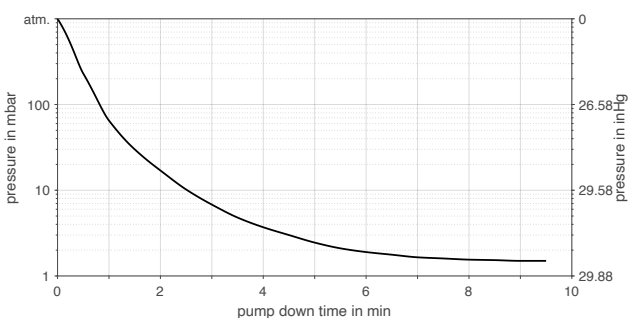

# N 952 KTE-W 50/60 HZ

## PERFORMANCE DATA

Material design	Flow rate at atm. pressure (l/min) <sup>1</sup>	Max. operating pressure (bar rel./psig)	Ultimate vacuum (mbar abs.)
N 952 KTE-W	32	0.1/1.4	2

<sup>1</sup>Flow rate determined at 20 °C, 1000 mbar abs.  
(Pressure 0 to 1000 mbar abs. in accordance with ISO 21360 / ISO 8778)

## N 952 KTE-W

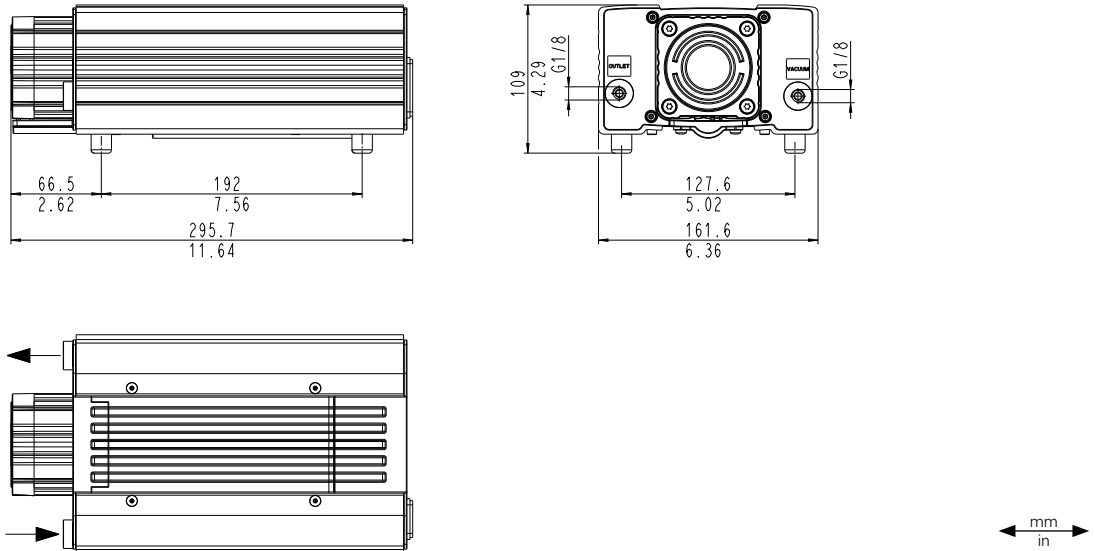

## N 952 KTE-W

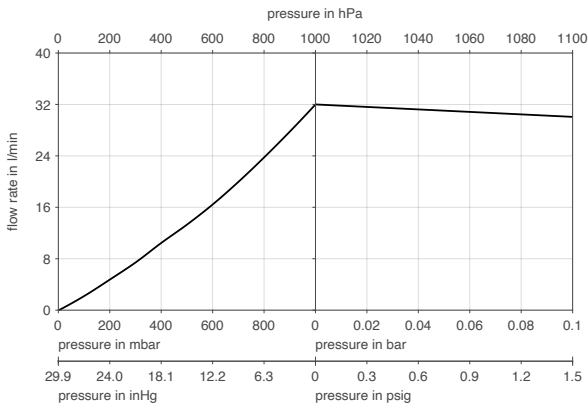

## N 952 KTE-W | SUCTION SPEED

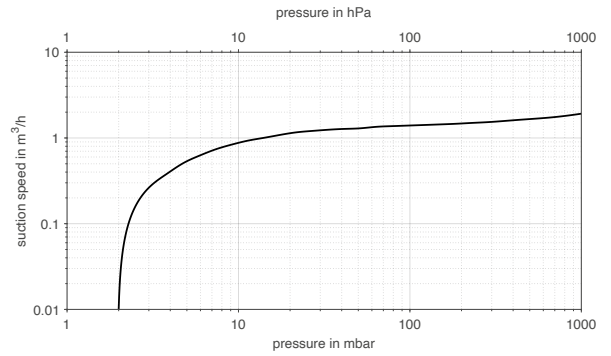

## N 952 KTE-W | PUMP DOWN TIME FOR 10 LITER VESSEL

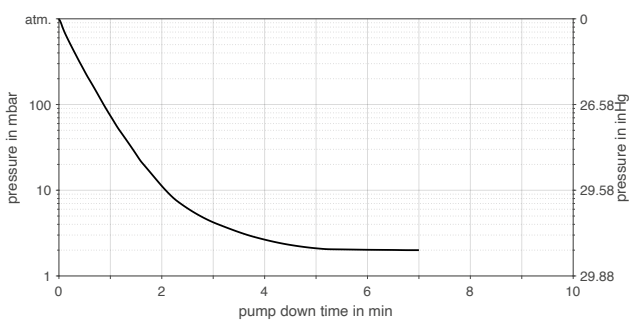

# N 952 KT.29 E-W 50/60 HZ

## PERFORMANCE DATA

Material design	Flow rate at atm. pressure (l/min) <sup>1</sup>	Max. operating pressure (bar rel./psig)	Ultimate vacuum (mbar abs.)
N 952 KT.29 E-W	9-32	0.1/1.4	2

<sup>1</sup>Flow rate determined at 20 °C, 1000 mbar abs.  
(Pressure 0 to 1000 mbar abs. in accordance with ISO 21360 / ISO 8778)

## N 952 KT.29 E-W

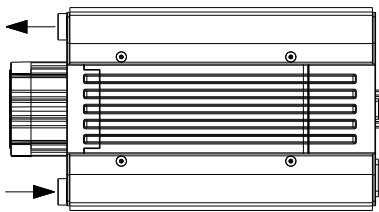
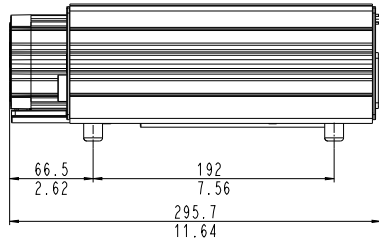

mm  
in

## N 952 KT.29 E-W

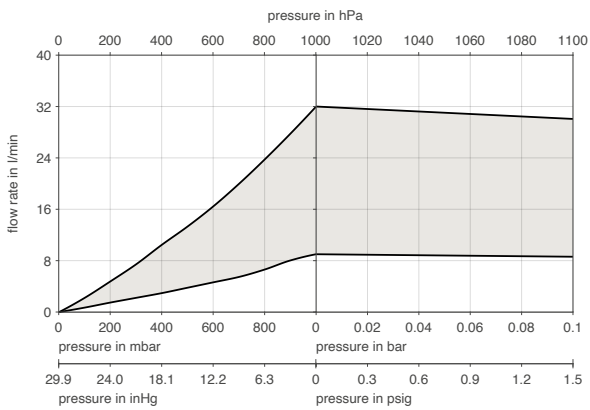

## N 952 KT.29 E-W | SUCTION SPEED

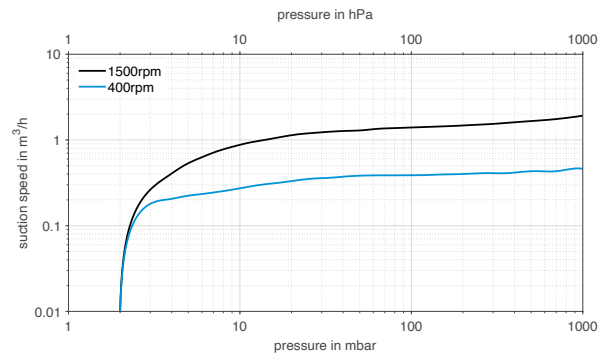



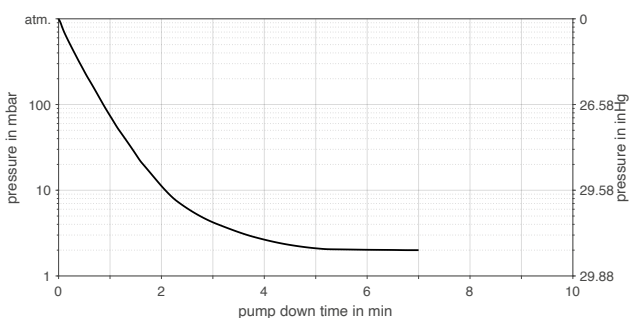

## N 952 KT.29 E-W | PUMP DOWN TIME FOR 10 LITER VESSEL







## DIGITAL CUSTOMIZATION

Thanks to digital technology, this pump can be quickly adapted to the customer's system. This is done by parametrizing the firmware of the motor at KNF.

ACCESSORIES			
Description	Illustration	Part No.	Details
NPT-Adapter		339159	1/8 NPT internal thread, G 1/8 external thread
Small flange		326040	G 1/8 external thread
Hose connector		048927	G 1/8, for hose ID 8, PVDF
Sealing ring		026906	G 1/8

SPARE PARTS			
Description	Illustration	Part No.	Details
Spare parts kit N 952 KN		339257	Spare parts kit consists of: 4x structured diaphragms, 10x valve plates, 16x O-rings, 16x screws. This set is required to maintain the pump.
Spare parts kit N 952 KT		339258	Spare parts kit consists of: 4x structured diaphragms, 10x valve plates, 16x O-rings, 16x screws. This set is required to maintain the pump.

The performance values for the series models shown on this data sheet were determined under test conditions. The actual performance values may differ and depend in particular on the usage conditions and therefore on the specific application, on the parameters of the components involved in the user's system and on any technical modifications carried out which deviate from the standard configuration or the as delivered condition.

If individual designs have been created for specific customers on the basis of series models, other technical performance data may apply. Before operation begins, the relevant operating instructions and/or assembly or installation instructions should be read and the safety information contained in these instructions should be noted. KNF reserves the right to make changes to the product and the associated documentation without prior notice to the customer.



[www.knf.com](http://www.knf.com)