

DRAW WIRE SENSOR

Links to further documents for this series:
[Installation guide](#)



ZX SERIES

Key-Features:

- Ultra-compact body
- Measurement range 38 mm
- Sensor element: potentiometer or hall effect device
- Linearity $\pm 1\%$
- Anodized aluminium housing
- Very low weight of 15 g
- Wire rope: Nylon jacketed stainless steel
- Easy mounting

Content

Technical Data	2
Technical Drawing	2
Electrical Connection	3
Warning Notices	3
Order Code	4
Accessories	4

TECHNICAL DATA

		ZX-PA	ZX-HM
Measurement range	[mm]	38	
Linearity	[%]	±1 (of full scale)	
Repeatability		±0.03 % (of full scale)	±0.08 mm
Resolution		depends on the signal quality of the reference voltage	0.04 mm
Dynamic	[Hz]	25 (over full range extension)	
Sensor element		Potentiometer	Hall-Effect device
Output signal		24.8 mV/mm at 1 VDC input voltage ¹⁾	89 % ± 3 % of power supply
Output impedance	[kΩ]	0..5	-
Input impedance	[kΩ]	5 ± 10 %	-
Min. load impedance	[kΩ]	-	min. 30
Power supply	[VDC]	max. 30	5 ± 0.25
Current consumption max.	[mA]	-	21
Connection		cable, 3 wires, length 457 mm	
Protection class		IP40	
Operating temperature	[°C]	-55...+100	-40...+100
Storage temperature	[°C]	-65...+100	-55...+100
Shock resistance		50 g, 0.1 ms max.	
Vibration resistance		15 g, 0.1 ms max.	
Life cycle		approx. 10,000,000 cycles	approx. 30,000,000 cycles
Extraction force	[N]	1.1	
Housing		anodized aluminium	
Draw wire		Nylon jacketed stainless steel, Ø 0.46 mm	
Weight	[g]	12	15

¹⁾ For nominal output in application, multiply value shown by actual excitation voltage.

TECHNICAL DRAWING

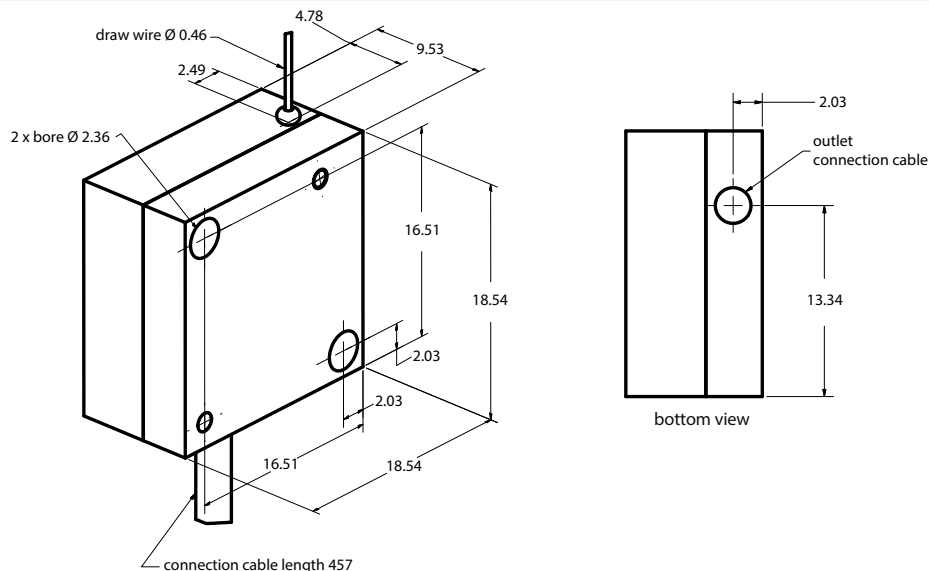

Draw wire attachment

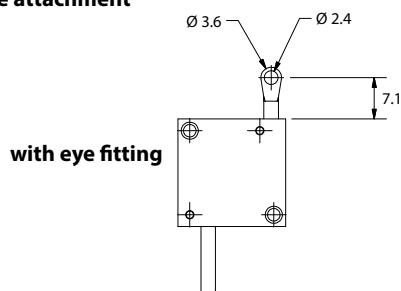

leader wire with fittings

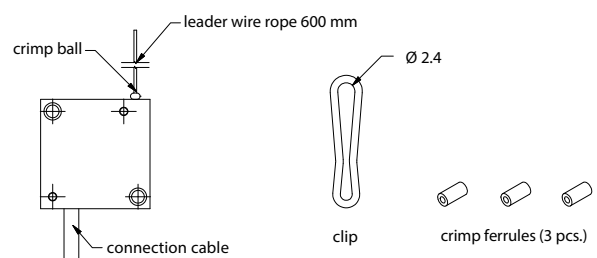

ELECTRICAL CONNECTION

Circuit diagram ZX-PA

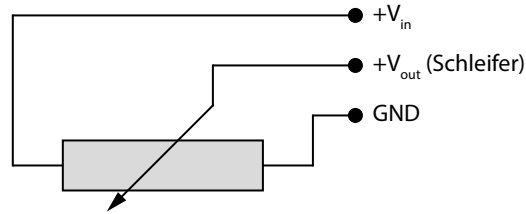

Cable output

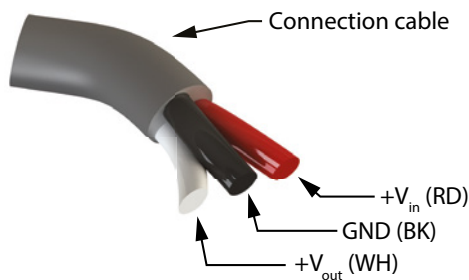

Connector output pin assignment

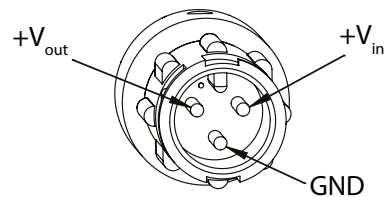

Connector output option C

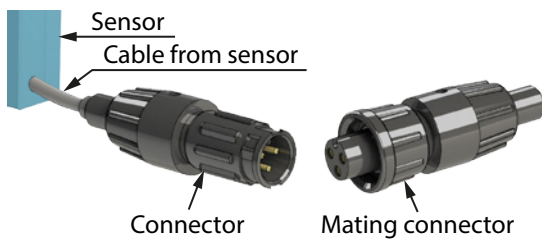

Connector output option K

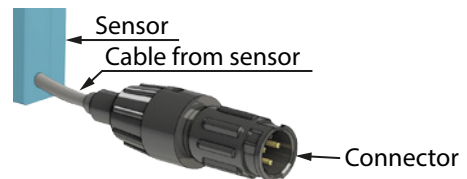

WARNING NOTICES

- Don't let the rope snap back. If the rope is retracted freely, this may lead to injuries (whiplash effect) and the device may be damaged.
- Caution when unhooking and retracting the rope into the sensor.
- Never exceed the specified measurement range when extracting the rope!
- Do not try to open the device. The stored energy of the spring drive may lead to injuries when being mishandled.
- Do not touch the rope when operating the sensor.
- Avoid guiding the rope over edges or corners. Use a deflection pulley instead.
- Do not operate the sensor if the rope is buckled or damaged. A ripping of the rope may lead to injuries or a damaging of the sensor.

ORDER CODE

ZX - - 1.5 -

Sensor element
Potentiometer
Hall-Effect Device

PA
HM

Draw wire attachment
With eye fitting
Leader wire with fittings

A
B

N
C
K

Connection type

Cable with open ends
Connector at cable with mating connector
Connector at cable without mating con.

P
Q
1
2

Cable length fixed cable

0.15 m
0.5 m
1 m (HM version only)
2 m (HM version only)

ACCESSORIES

Connection cable for option K

10248-1M	cable 1 m, with mating connector
10248-2M	cable 2 m, with mating connector
10248-3M	cable 3 m, with mating connector
10248-4M	cable 4 m, with mating connector
10248-5M	cable 5 m, with mating connector

Digital displays for sensors with analog output, 2 channel

WAY-AX-S	touch screen, supply: 18...30 VDC
WAY-AX-AC	touch screen, supply: 115...230 VAC

For more information and options please refer to the [WAY-AX data sheet](#).