



Mass Spectrometers for Thin Films, Plasma & Surface Engineering

MASS SPECTROMETERS

for Thin Films, Plasma & Surface Engineering

Hidden Analytical have been designing and developing the highest quality quadrupole mass spectrometer based systems for over 35 years. We have built a reputation for delivering instruments with superior sensitivity, accuracy and reproducibility together with a first class global service and applications support network.

Thin film processing in research, development and functionalisation of surfaces has a broad application range in microelectronics, nanotechnology, solar, flat panel, mechanics, optics, photonics, textiles, coatings, chemistry, biology and medicine.

THIN FILM PROCESSING UTILISES A WIDE RANGE OF TECHNIQUES, INCLUDING:

- ▶ Magnetron sputtering
- ▶ ALD – Atomic Layer Deposition
- ▶ CVD – Chemical Vapour Deposition
- ▶ MOCVD – Metal Organic Chemical Vapour Deposition
- ▶ PECVD – Plasma Enhanced Chemical Vapour Deposition
- ▶ MBE – Molecular Beam Epitaxial growth
- ▶ RIE – Reactive Ion Etch
- ▶ IBE/RIBE – Ion Beam Etch and Reactive Ion Beam Etch

Each technique is often tailored for a specific application, requiring special process parameters to produce the surface/film properties required.

Hidden mass spectrometers provide critical insight into thin film processing and characterisation enabling optimisation of thin film production and surface quality. Hidden systems are individually configured to ensure optimum analyser response for sensitivity and speed.



Contents



AutoSIMS

HMT - High Pressure Residual Gas Analyser

HPR-30 & RGA - Process and Residual Gas Analysis

PSM - Plasma Sampling Mass Spectrometer

EQP - Analysis of Positive and Negative Ions, Neutrals and Radicals

HPR-60 MBMS - for Ion and Radical Analysis at Atmospheric Pressure

ESPion - Advanced Langmuir Probe for Plasma Diagnostics

IMP-EPD - End Point Detector for Ion Beam Etch

XBS - Deposition Rate Monitor for Molecular Beam Analysis and Deposition Control

TPD WORKSTATION - A System for UHV Temperature Programmed Desorption (TPD/TDS) Studies

SECONDARY ION MASS SPECTROMETRY (SIMS) SYSTEMS - for Materials and Surface Analysis

SIMS COMPONENTS - Add SIMS Capability

SIMS SOFTWARE - SIMS Mapper, Ion Gun Controller

MASsoft SOFTWARE - Flexible, Powerful Software for a Wide Range of Applications



EQP

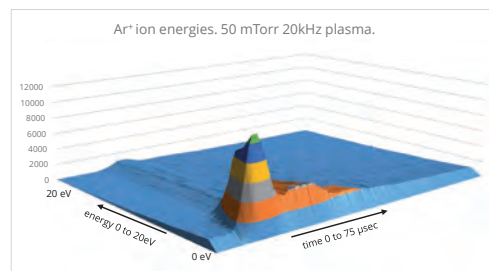

MCS - Multi-channel scaler mode for pulsed plasma analysis

HMT

High Pressure Residual Gas Analyser

Monitoring vacuum processes with a conventional RGA at pressures $>10^{-4}$ Torr typically requires the addition of differential pumping. Alternative analyser types optimised for high pressure operation have degraded sensitivity at low pressures.

The innovative Hiden HMT analyser enables operation at high pressure yet maintains full RGA performance at high vacuum with dual mode operation:

- ▶ UHV mode for high performance residual gas analysis at pressure $<10^{-4}$ Torr through to 10^{-13} Torr
- ▶ High pressure mode for measurement at pressures $>10^{-4}$ Torr through to 5×10^{-3} Torr

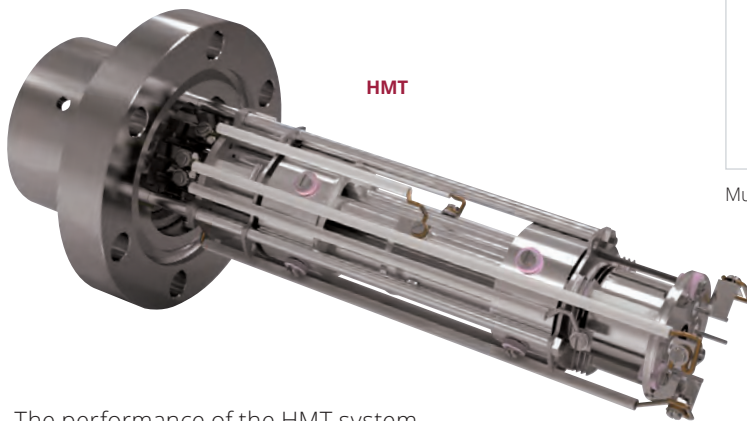

The performance of the HMT system operating in high pressure mode is illustrated in the graphs below where Argon fill gas flow is increased progressively.

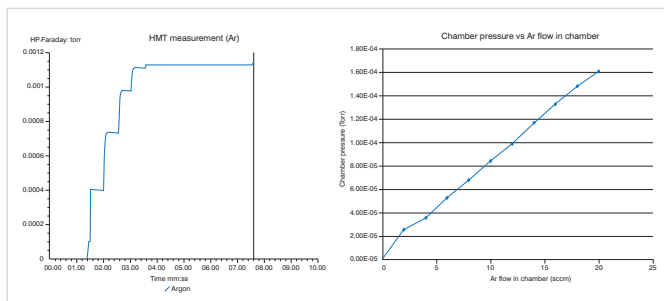

HMT Analyser measuring Argon in the process chamber at pressure up to $>10^{-4}$ Torr.

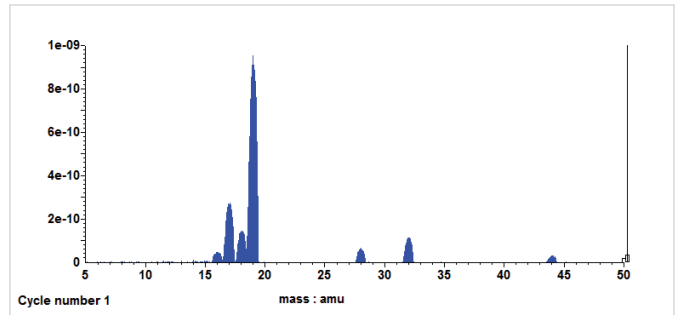

Profile mass scanning in RGA high sensitivity mode.

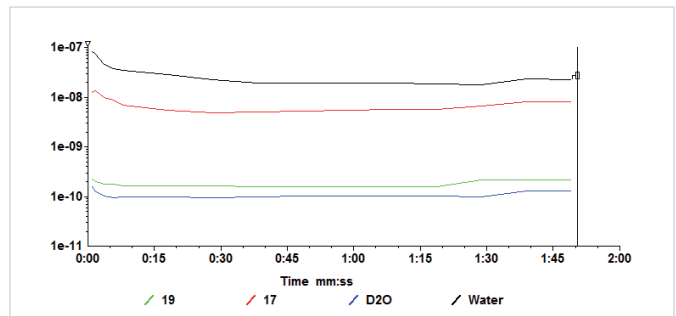

Multi-component trend analysis.

FEATURES:

- ▶ HMT mode for high pressure operation to 5×10^{-3} Torr
- ▶ RGA mode for high sensitivity operation to 10^{-13} Torr
- ▶ 100 amu mass range
- ▶ Stability better than $\pm 1\%$ over 24 hours
- ▶ Fast access mixed mode scanning
- ▶ Real-time background subtraction

HPR-30

Process and Residual Gas Analysis

The HPR-30 is a residual gas analyser configured for analysis of gases and vapours in vacuum processes and for vacuum diagnostics. The system is fully configurable for individual process applications such as CVD, plasma etching, MOCVD, process gas purity and in-process contaminant monitoring.

The HPR-30 system features a close-coupled re-entrant aperture for sampling directly within the process region, providing maximum data integrity and fast confirmation of process status. Options include the innovative Hiden 3F series triple filter quadrupole system providing enhanced abundance sensitivity, parts-per-billion (ppb) detection levels and high contamination resistance, particularly suited to the analysis of aggressive gases in CVD and RIE applications.

The HPR-30 sampling system configuration is directly suited to analysis of high mass species and precursors used in ALD and MOCVD applications.

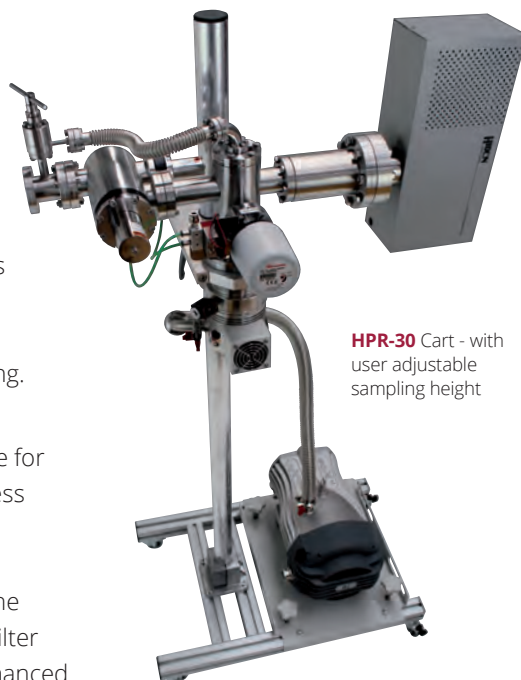

HPR-30 Cart - with user adjustable sampling height

PRODUCTS

RGA Series – residual gas analysers for vacuum measurement through to fundamental scientific research.

qRGA with separation of He/D₂, ³He/HD/T and deuterated hydrocarbons (e.g. C_xH_y and C_xD_y) with mass range to 200 amu.

HPR-30 Series – vacuum process analysers configured for high sensitivity, fast response gas and vapour analysis of thin film deposition and etching processes: CVD, ALD, MOCVD and RIE for example.



RGA series

FEATURES/OPTIONS:

- ▶ Custom inlet systems with optimised sampling for metals and metal organic vapours
- ▶ High mass range options available – 500 and 1000 amu
- ▶ High sensitivity RGA for UHV quality chamber base pressure measurements and leak detection
- ▶ Re-entrant sampling orifice for fast response to process gas/vapour composition changes
- ▶ Gas/vapour sampling systems optimised for response and sensitivity over a wide pressure range

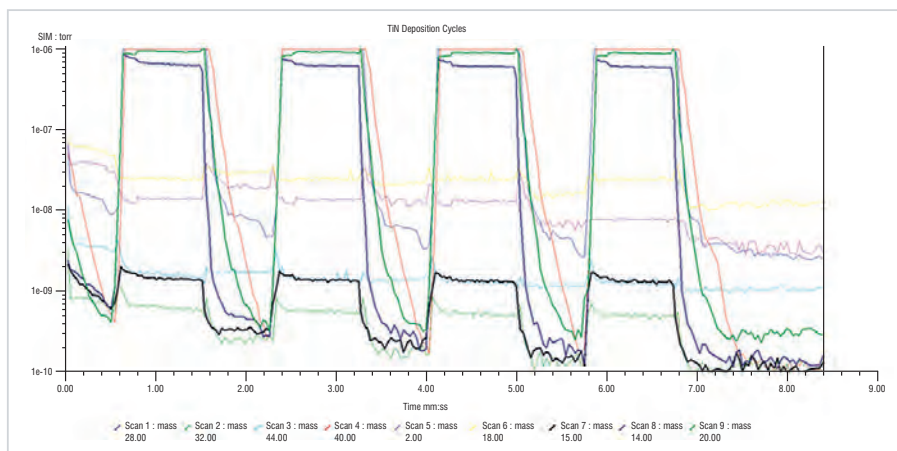

HPR-30 data on TiN deposition

PSM

Mass/Energy Analyser for Positive Ions, Neutrals and Radicals from Plasma

The Hiden PSM plasma ion analyser is a quadrupole mass spectrometer designed for direct analysis of plasma ions, and neutrals in both plasma characterisation and process diagnostic applications.

The PSM system includes ion extraction/exclusion optics with integral electron impact ioniser, triple filter mass analyser and an in-line energy analyser. The energy analyser enables ion energy distribution measurements for selected plasma ions. The ion extraction/exclusion optics serve to remove the background spectrum effects caused by plasma ions, thereby increasing the overall sensitivity to neutral species sampled from plasma when compared with conventional RGAs. The control of the PSM electron impact ioniser provides for neutral radical analysis by appearance potential threshold ionisation mass spectrometry (TIMS).

Mass range is 300 amu. Energy range is to 100 eV. The plasma sampling orifice insertion length is up to 230 mm.

The interchangeable sampling orifice is mounted in the probe tip. Standard orifices accommodate the pressure regime up to 0.5 mbar with 60 l/s differential pumping. Options extend this range to 2.0 mbar, 20 mbar, 100 mbar and atmospheric sampling.

APPLICATIONS:

- ▶ Radical and ion analysis in plasma chemistry studies
- ▶ Pulsed plasma studies
- ▶ Nano particle detection in pulsed plasma
- ▶ Plasma etch studies/end point detection
- ▶ Pulsed laser deposition studies
- ▶ ECR plasma studies

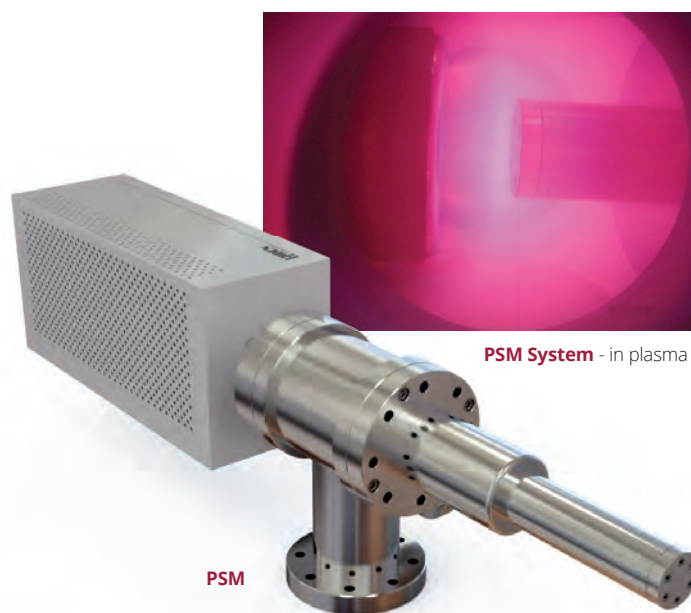

FEATURES:

- ▶ Positive ion analysis of process plasma ions
- ▶ Plasma ion energy analysis with integral Bessel Box energy analyser
- ▶ Integral RGA mode for measurement of process neutrals, process contamination and leak detection
- ▶ Optional integrated 50 ns Time Resolved Mode for HiPIMS and pulsed plasma studies
- ▶ MASsoft Professional PC software

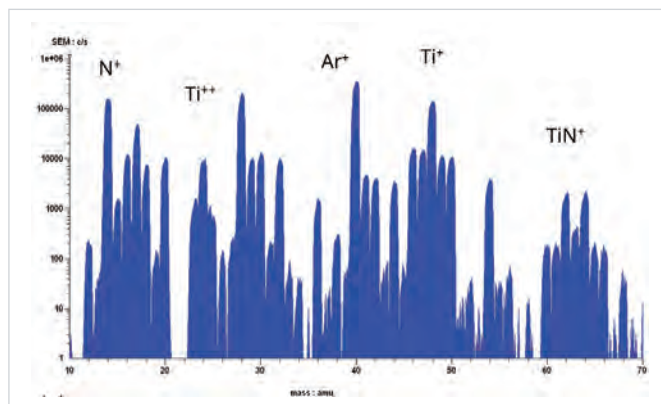

Positive Ion species

EQP

Mass/Energy Analyser for Ions, Neutrals and Radicals from Plasma



EQP System - in plasma

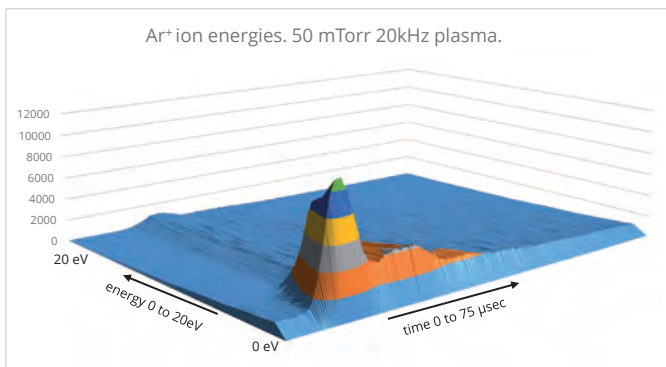
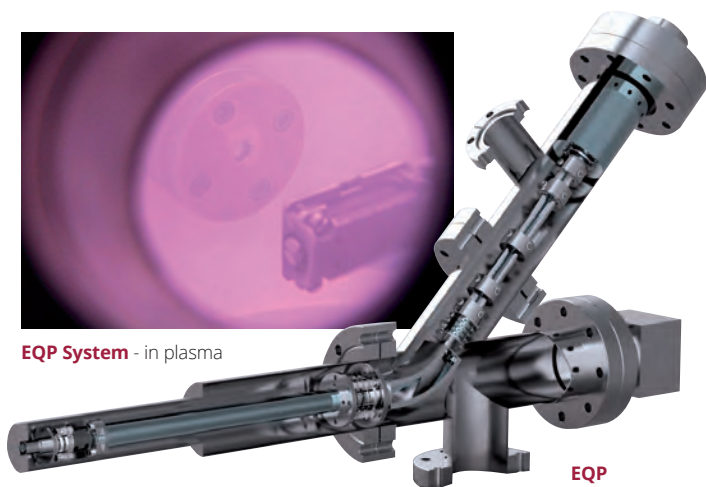

MCS - Multi-channel scaler mode for HiPIMS and pulsed plasma analysis

FEATURES:

- ▶ +ve and -ve ion analysis
- ▶ Appearance potential spectra for radicals analysis
- ▶ Electron attachment ionisation mode option for analysis of electronegative radicals
- ▶ Magnetic shielding options for operation in magnetically confined plasmas
- ▶ Integral RGA mode for measurement of process neutrals, process contamination and leak detection
- ▶ Integral sector field energy analyser for ion energy distributions
- ▶ MASsoft Professional PC software
- ▶ Optional integrated 50 ns Time Resolved Mode for HiPIMS and pulsed plasma studies

The Hiden EQP Series quadrupole mass spectrometer systems are designed for direct analysis of plasma ion mass and energy in both plasma characterisation and process diagnostic applications.

EQP systems measure both positive and negative ions. The integral electron bombardment ion source enables neutrals analysis and features an advanced appearance potential scanning routine. Additionally the Electron Attachment Ionisation mode is developed specifically for studies of electro-negative species.

Mass range options are 300 amu, 510 amu, 1000 amu and for plasma clusters up to 5000 amu. Energy range is 100 eV as standard, 1000 eV is optional.

The interchangeable sampling orifice is mounted in the probe tip. Standard orifices accommodate the pressure regime up to 0.5 mbar with 60 l/s differential pumping. Options extend this range to 2.0 mbar, 20 mbar, 100 mbar and atmospheric sampling.

The EQP ion optics are adaptable to most plasma chambers, large or small. The plasma sampling orifice insertion can be extended up to 750 mm. Magnetic shielding options provide for operation in magnetically confined plasmas.

Advanced signal detection capabilities include the integrated multi-channel scaler (MCS) mode option with data bin width to 50 nanoseconds for time resolved studies in pulsed plasma.

The EQP system is suited for advanced plasma research applications including:

- ▶ Time resolved measurements in HiPIMS
- ▶ Plasma studies in PECVD
- ▶ Silane plasma characterisation
- ▶ Plasma source studies
- ▶ Pulsed laser ablation
- ▶ Plasma etch
- ▶ Radical analysis in plasma chemistry studies
- ▶ Reaction kinetics studies

HPR-60 MBMS

for Ion and Radical Analysis at Atmospheric Pressure

The Hiden HPR-60 molecular beam mass spectrometer is a compact skimmer inlet MS for the analysis of reactive gas phase intermediates. Radicals are sampled via a multi-stage differentially pumped skimmer inlet and transferred to the MS ion source with minimal interaction with other species and without wall collisions. Customisable inlets allow connection to many different reactor systems, including atmospheric plasmas, flame and combustion studies and CVD vapours.

The skimmer system, combined with a Hiden triple filter precision mass spectrometer, offers a sampling system with ultra-fast response and high accuracy.

APPLICATIONS INCLUDE:

- ▶ Plasma chemistry
- ▶ Reaction kinetics
- ▶ Study of transients
- ▶ Catalytic reactors

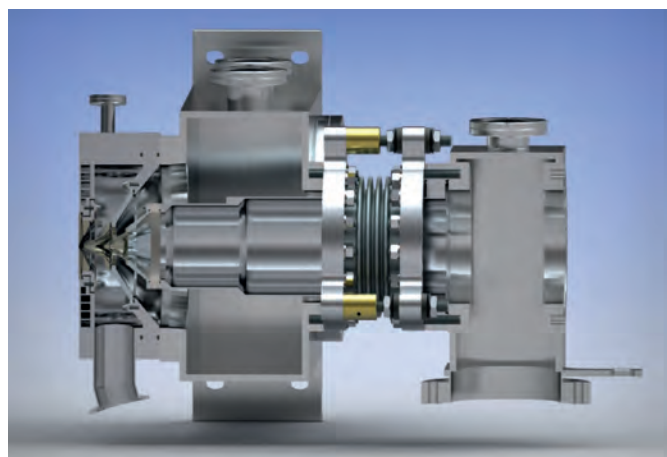

Molecular beam inlet

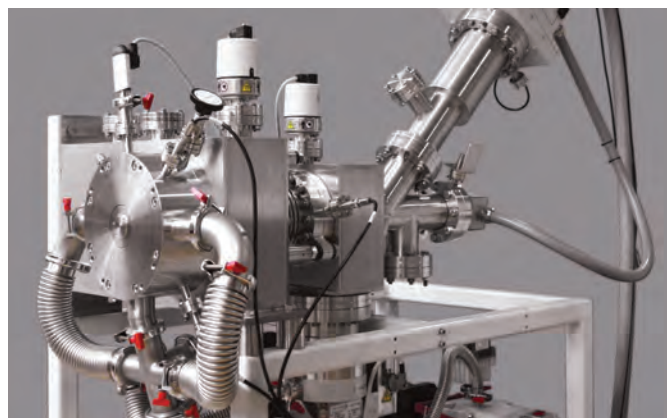

HPR-60 MBMS

FEATURES:

- ▶ Molecular beam sampling at atmospheric pressure
- ▶ +ve and -ve ion analysis
- ▶ User replaceable skimmer cones (can be biased)
- ▶ Electron attachment ionisation mode for the study of electro-negative radicals
- ▶ APSI-MS soft ionisation mode for radicals analysis
- ▶ Mass range options: 300, 510, 1000 or 5000 amu for high mass cluster studies
- ▶ Energy range options: 100 eV or 1000 eV
- ▶ Integrated MCS mode option for analysis of pulsed plasma with temporal resolution of 50 ns

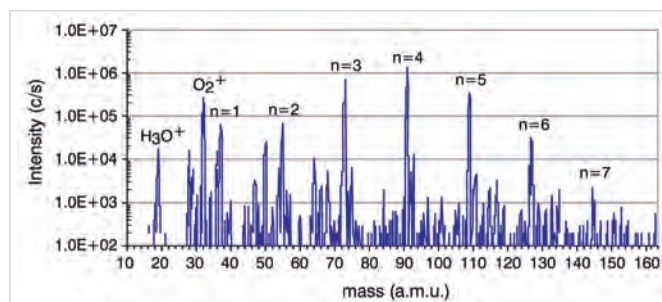

Hydrated cluster ions from an atmospheric dielectric barrier discharge

ESPion

Advanced Langmuir Probe for Plasma Diagnostics

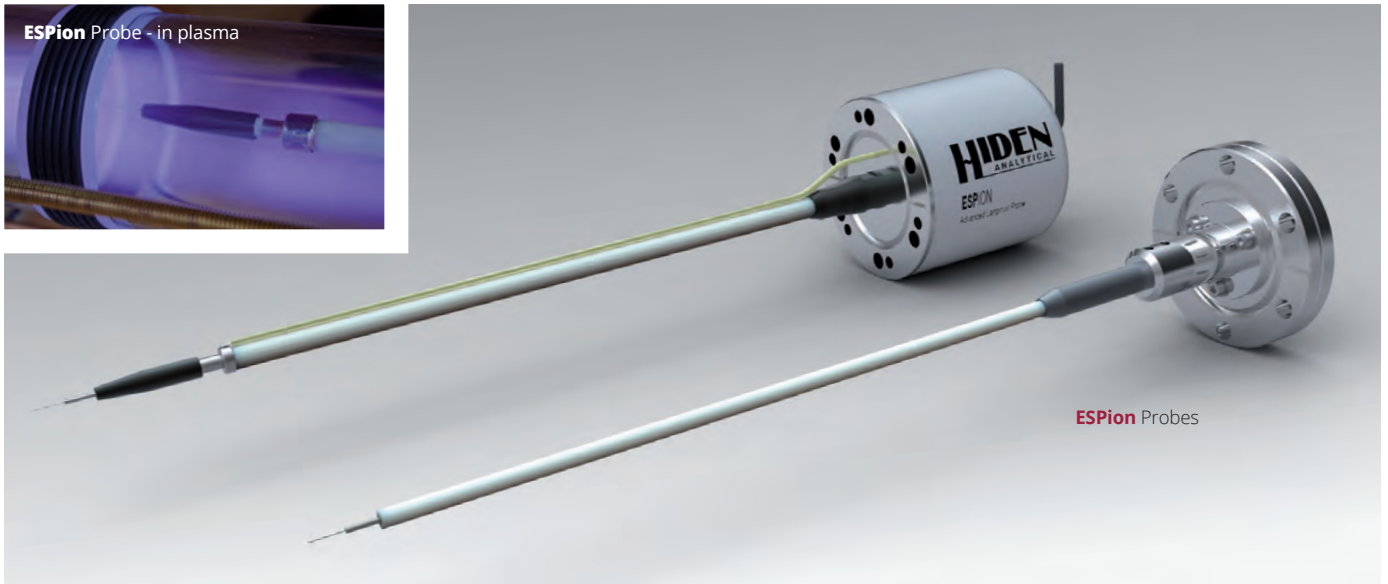
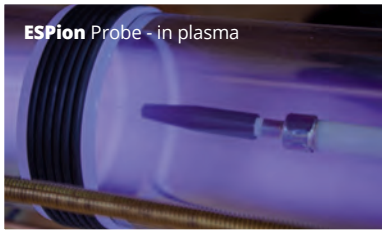

The ESPion Langmuir probe provides for measurement of the electrical properties of plasmas including:

- ▶ Plasma potential
- ▶ Floating potential
- ▶ Electron temperature
- ▶ Electron density
- ▶ Ion density
- ▶ Electron energy distribution
- ▶ Ion flux

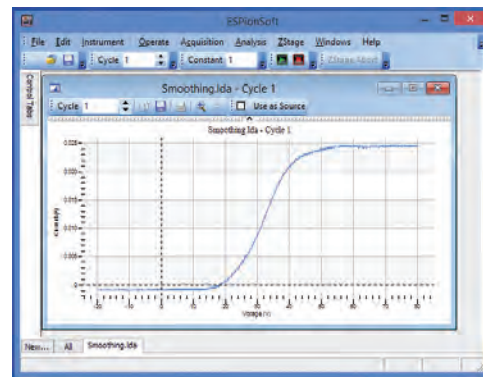

ESPion Data

Routine monitoring of the I-V plasma characteristic by the Hiden ESPion probe gives direct information relating to plasma stability and reproducibility. Automatic real-time extrapolation of plasma parameters gives detailed information on plasma properties for use in characterisation and uniformity monitoring.

The ESPion system employs Orbital Motion Limited (OML) and Allen Boyd Reynolds (ABR) as standard plasma analysis models.

The Hiden automatic Z-drive provides for spatially resolved measurements across the plasma volume. The standard Z-drive translation options are: 300, 600 and 900 mm.

FEATURES:

- ▶ Ion and electron density over the range 10^{14} - 10^{19} m⁻³
- ▶ Electron temperature up to 10 eV
- ▶ Electron Energy Distribution Function (EEDF)
- ▶ Plasma potential
- ▶ Floating potential
- ▶ Debye length
- ▶ Developed for pulsed, DC, RF and ECR plasma
- ▶ Integrated signal gating for pulsed plasma analysis

IMP

End Point Detector for Ion Beam Etch

The IMP-EPD is a differentially pumped, ruggedised secondary ion mass spectrometer for the analysis of secondary ions and neutrals from the ion beam etch process. The system includes integrated software with process specific algorithms developed for optimum process control.

The IMP-EPD system is process proven for the production of high specification thin film devices for applications including magnetic thin films, high temperature superconductors and III-V semiconductors.

END POINT CONTROLS

- ▶ Rising and falling edge algorithms
- ▶ Layer counting for End Point on a selected interface in a multilayered stack
- ▶ End Point relative to a reference peak
- ▶ Automatic signal correction due to wafer rotation

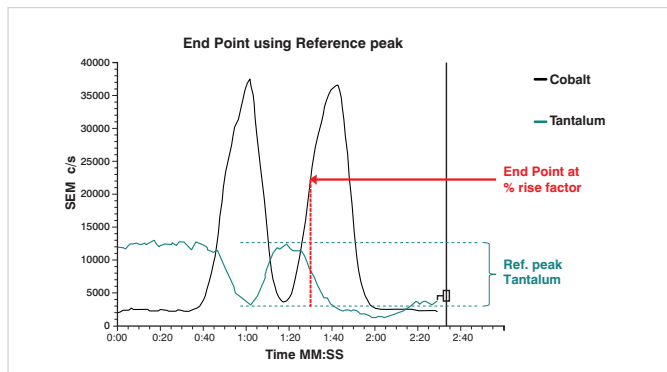

Flexible and high resolution End Point

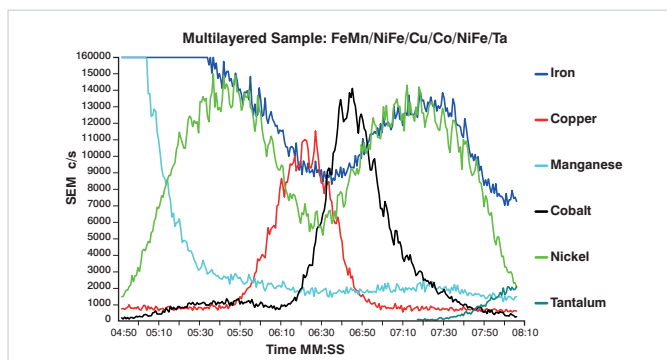

Real-time etch monitoring – zoom view

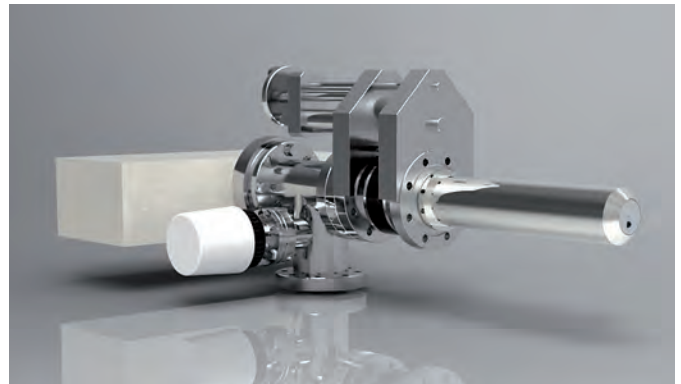

IMP-EPD

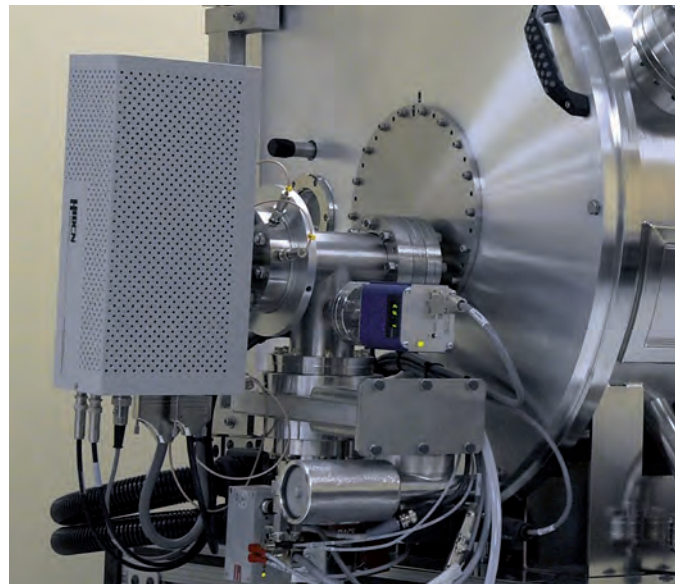

IMP-EPD on processing tool

FEATURES:

- ▶ Automatic End Point Detection
- ▶ High resolution End Point, down to < 0.5 nm
- ▶ Ruggedised for Processing
- ▶ High sensitivity SIMS analysis
- ▶ Integrated residual gas analyser mode for process chamber vacuum diagnostics

XBS

Deposition Rate Monitor for Molecular Beam Analysis & Deposition Control

The Hiden XBS system is a quadrupole mass spectrometer designed for monitoring multiple beam sources simultaneously and uniquely offers beam acceptance through a 70° cone. Species-specific analogue signals are used for beam intensity output to the users' source control modules.

Beam acceptance apertures are configured individually for each specific process chamber source position, manufactured as replaceable plug-in elements to enable retrospective modification in event of chamber alteration. Purpose-designed with high contamination resistance for monitoring evaporating components and fragments in MBE processes. Manufactured with a triple stage mass filter and water-cooled fully-shrouded probe to protect the probe from the radiant heat sources and to inhibit probe contamination.

- ▶ **Monitor and control in MBE processes**
- ▶ **Molecular beam studies**
- ▶ **Multiple beam source analysis**
- ▶ **Photoionisation studies**
- ▶ **Desorption/outgassing studies**
- ▶ **Monitoring and diagnostics of contaminants in the process chamber**
- ▶ **High performance RGA with 3F series triple-stage mass filter**
- ▶ **High-sensitivity helium leak check mode for vacuum quality verification**



XBS probe

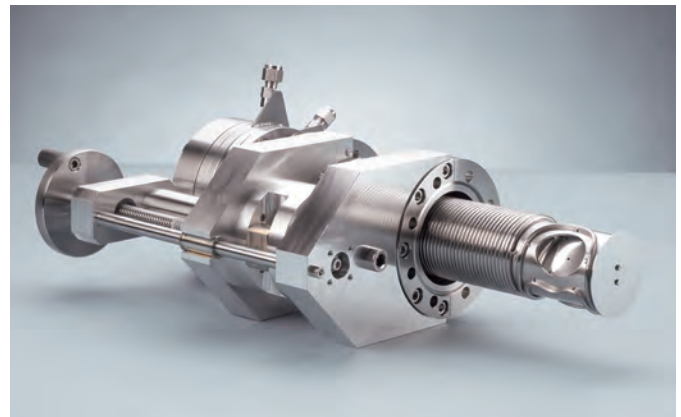

XBS probe with water-cooled shroud and Z-drive

FEATURES:

- ▶ High sensitivity - minimum detectable partial pressure 2.5×10^{-14} mbar
- ▶ Mass range: 320 or 510 amu
- ▶ Crossbeam ion source, beam acceptance through $\pm 35^\circ$ to transverse axis
- ▶ Beam acceptance apertures configured for beam source positions
- ▶ Growth rate determination typically $< 0.01 \text{ \AA s}^{-1}$ (species dependent)
- ▶ Optional water-cooled shroud

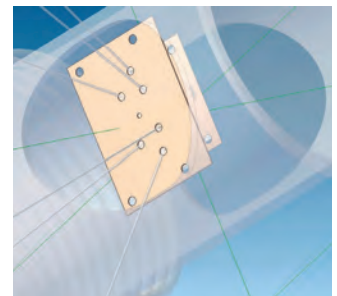
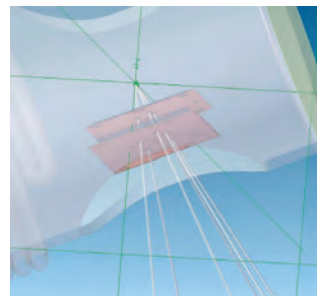

Beam acceptance apertures

TPD WORKSTATION

A System for UHV Temperature Programmed Desorption (TPD/TDS) Studies

The Hiden TPD Workstation is a complete experimental system for analysis of thermal desorption products by UHV TPD/TDS. The TPD Workstation features a multiport UHV chamber with heated sample stage coupled to a high precision triple filter analyser with digital pulse ion counting detector for ultimate sensitivity and time resolution. The triple filter mass analyser is configured with a cooled shroud giving minimal outgassing with optimum sensitivity of the analyser to desorption products from the sample. A fast sample load lock with sample transfer mechanism is included to provide for rapid sample change. The unique sample transfer mechanism means only the sample is transferred from the load lock to the heater stage ensuring no sample holder outgassing during the TPD experiment.

Hiden's TPDsoft thermal analysis PC software included with the Workstation provides automatic control of sample temperature integrated with analyser control. TPD analysis routines (e.g. peak integration, deconvolution and background subtraction etc.) are also included in this package.

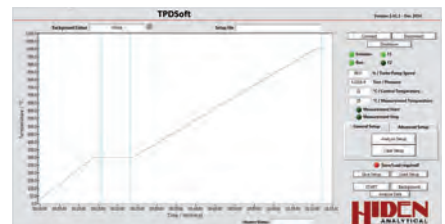
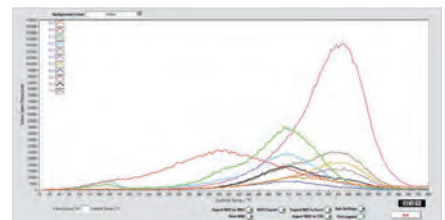
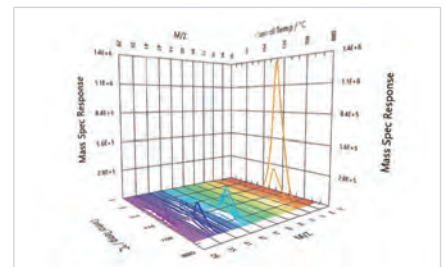

TPD Workstation with hot sample

TPDsoft for control and analysis of TPD experiments

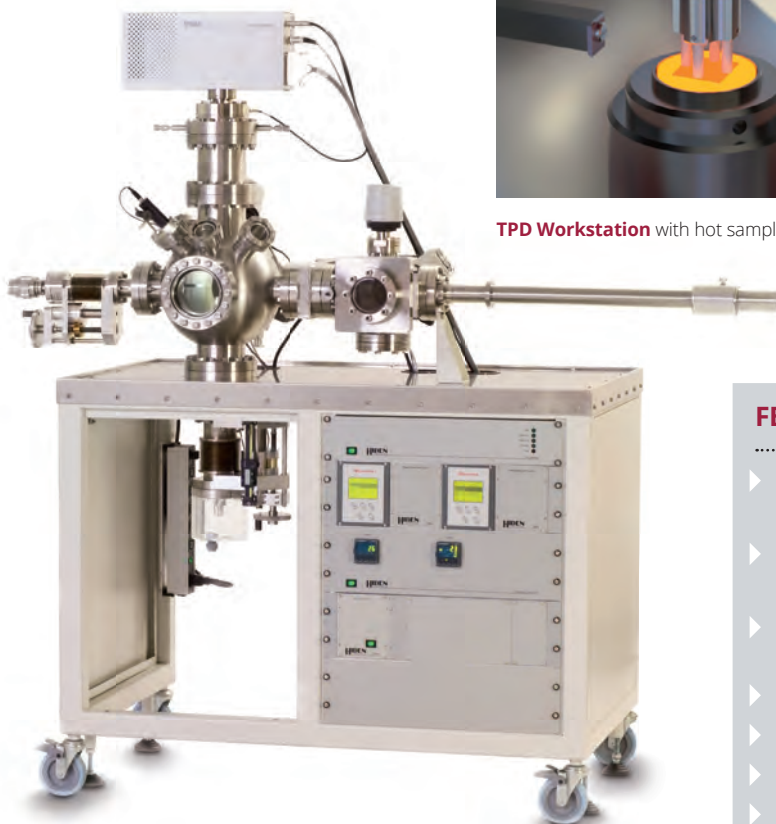

TPD Workstation

FEATURES:

- ▶ Hiden 3F PIC mass spectrometer for fast data acquisition (> 500 data points per second)
- ▶ Multiport UHV chamber for attachment of additional instrumentation (e.g. ellipsometry)
- ▶ Sample transfer mechanism and load lock, including gate valve and viewport
- ▶ Heated sample stage to 1000°C
- ▶ Z-drive for optimum sample/detector positioning
- ▶ Bakeout jacket (200°C max)
- ▶ Integrated software control of experimental protocols

SECONDARY ION MASS SPECTROMETRY (SIMS) SYSTEMS

for Reliable and Flexible Analysis of Materials and Surfaces

The Hiden family of SIMS systems ranges from automated tools for production control and repetitive analysis, through to full UHV instruments for advanced materials research. All are constructed using industry standard UHV components and are based around the high transmission Hiden MAXIM series spectrometers.

For routine analysis the IG20 gas ion gun (with oxygen) provides unrivalled reliability and ease of use. The Workstation series instruments are also available with the IG5C Caesium ion gun allowing sensitive measurement of electronegative elements as well as the information rich MCs⁺ detection mode. Some instruments are also equipped with Sputtered Neutral Mass Spectrometry detection systems, allowing reliable quantification of matrix level components.

Compact SIMS – economical high performance SIMS for routine analysis, education and general laboratory applications.



Compact SIMS

FEATURES:

- ▶ Detect elements, molecules and isotopes
- ▶ Static SIMS (surface specific) and dynamic SIMS (depth profiling)
- ▶ Nanometre depth resolution
- ▶ Chemical imaging
- ▶ Quantitative analysis
- ▶ Measurement depth from top monolayer to over 30 microns.

AutoSIMS – self-contained automated instrument for unattended, programmed, analysis anywhere in a sample area of 100 mm x 60 mm. Available with custom sample holders for greatest efficiency.

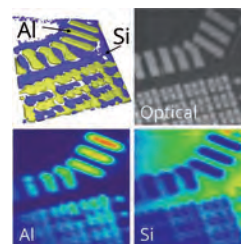

Mass Resolved Imaging



AutoSIMS

SIMS Workstations – fully featured UHV surface analysis tools available with the industry standard oxygen and caesium ion sources, high transmission MAXIM spectrometer with Sputtered Neutral Mass Spectrometry (SNMS) and oxygen jet for topography control. The use of standard components and a large chamber means the systems can also be easily customised.



SIMS Workstation

SIMS COMPONENTS

Add SIMS Capability

A range of easily fitted and configurable SIMS components allow this powerful analysis technique to be used with existing chambers as well as in the construction of bespoke systems for special applications. With nanometre precision and high chemical sensitivity, SIMS is ideal for monitoring the results of deposition, measuring diffusion, investigating failure and reverse engineering in a wide range of material systems.

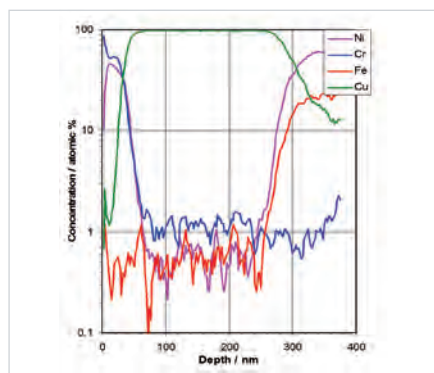

SNMS - Hard disk head layer structure

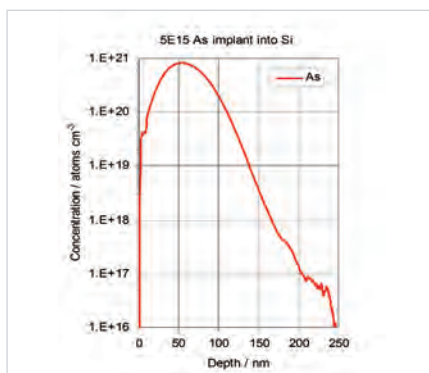

SIMS - Arsenic implant in Si

IG20 Gas Ion Gun – A rugged twin filament ion source for reliable operation with a variety of gasses including oxygen and noble gasses. The ideal gun for general depth profiling and spectrometry.

IG5C Caesium Ion Gun – an advanced ion gun for sensitive detection of electronegative elements and using the powerful MCs^+ mode. Caesium ions are created in an easily replaceable thermal desorption/surface ionisation source.

MAXIM Spectrometer - available in both 6 mm and 9 mm triple filter configuration, the parallel plate energy filter gives highest sensitivity and compact construction. An electron impact ioniser at the entrance aperture gives the highest solid angle collection for measurement of neutrals in the sputtered neutral mass spectrometry (SNMS) mode for monitoring high concentration components independent of the "Matrix Effect".

EQS Spectrometer – the slim profile of the EQS means that it is easily fitted to existing tools such as XPS systems and FIB microscopes. The 45 degree electrostatic sector also provides superior energy resolution for surface science applications. A differentially pumped version is available for higher pressure SIMS.

FEATURES:

- ▶ Ion guns include electronics for accurate beam current and profile measurement (electron suppressed Faraday system)
- ▶ Spectrometers are self-tuning and include an internal ion source for RGA measurement
- ▶ Uses the same software packages as the SIMS Workstation



IG20 Gas Ion Gun

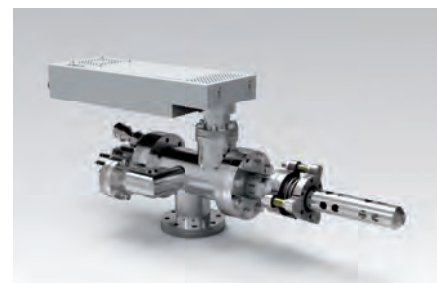

IG5C Caesium Ion Gun



MAXIM SIMS/SNMS Spectrometer



EQS SIMS Spectrometer

SOFTWARE

SIMS SOFTWARE

Fast, flexible, informative

All Hiden SIMS instruments run both the Hiden MASsoft and SIMS Mapper Software giving unprecedented flexibility for the expert and reliable easy to use options for more routine tasks.

SIMS MAPPER

The SIMS Mapper software suite collects data as stacked images for later 3D reconstruction and depth profile extraction. Gating of the data stack can be done during and after acquisition in user defined locations. The wide range of export options, built in periodic table and mass interference calculator make the software easy to use and standard templates can be set up to run automatically.

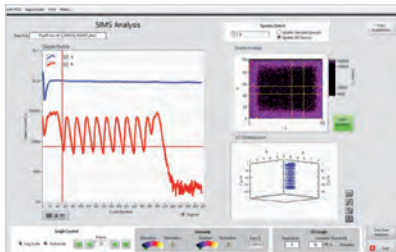

SIMS Mapper Acquisition Window

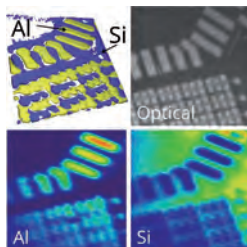

Mass Resolved Imaging

ION GUN CONTROLLER

With a library of saved parameters the ion guns can rapidly switch between bombardment conditions and can be set to start and close automatically. The power supplies are self-monitoring and incorporate controlled ramp rates to protect sensitive components like the Cs source.

MASsoft PROFESSIONAL

All Hiden Mass Spectrometers are supplied with MASsoft mass spectrometer PC control software.

MASsoft Professional software is intuitive and multi-level offering simple operation for a novice user whilst incorporating a broad range of useful and advanced features for the vacuum expert. Software/Firmware data control features available include:

- ▶ **TTL pulse output**
- ▶ **Programmable signal gating**
- ▶ **Foreground/background counters for automated background subtraction with molecular beam choppers**
- ▶ **Socket interface for control from users' software applications**
- ▶ **LabVIEW drivers**
- ▶ **MCS mode - multi-channel scaler data acquisition with minimum bin width 50 nanoseconds**
- ▶ **Endpoint digital recipe selection for process tool integration**
- ▶ **Endpoint method templates – addressing a wide range of endpoint applications**

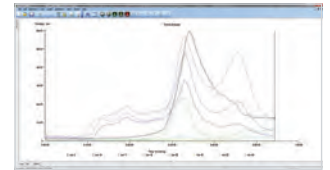

Trend Analysis

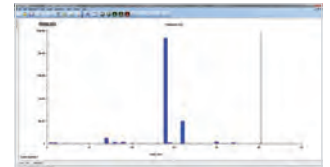

Mass scan - histogram

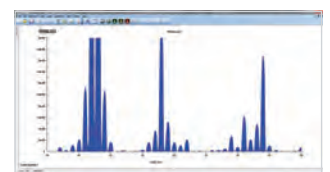

Mass scan - profile

FEATURES:

- ▶ Template driven quick start operation
- ▶ Multiple RGA operation over ethernet link
- ▶ Real-time data display with zoom feature
- ▶ Mixed mode scanning including trend analysis view of selected species from broad mass scans
- ▶ Statistical analysis and peak integration
- ▶ Accessible data with copy/paste functions and automated data export
- ▶ Auto mass alignment
- ▶ Integrated mass spectral library

Hidden **APPLICATIONS**

Hidden's quadrupole mass spectrometer systems address a broad application range in:

GAS ANALYSIS

- ▶ dynamic measurement of reaction gas streams
- ▶ catalysis and thermal analysis
- ▶ molecular beam studies
- ▶ dissolved species probes
- ▶ fermentation, environmental and ecological studies



SURFACE ANALYSIS

- ▶ UHV TPD
- ▶ SIMS
- ▶ end point detection in ion beam etch
- ▶ elemental imaging – 3D mapping

HIDEN

ANALYTICAL

Hidden Analytical Ltd.
420 Europa Boulevard
Warrington WA5 7UN England

T +44 [0] 1925 445 225

F +44 [0] 1925 416 518

E info@hidden.co.uk

W www.HiddenAnalytical.com



Sales Offices:

We have sales offices situated around the globe. **Visit our website for further information.**



PLASMA DIAGNOSTICS

- ▶ plasma source characterisation
- ▶ etch and deposition process reaction kinetic studies
- ▶ analysis of neutral and radical species



VACUUM ANALYSIS

- ▶ partial pressure measurement and control of process gases
- ▶ reactive sputter process control
- ▶ vacuum diagnostics
- ▶ vacuum coating process monitoring