

Mod.
PRM

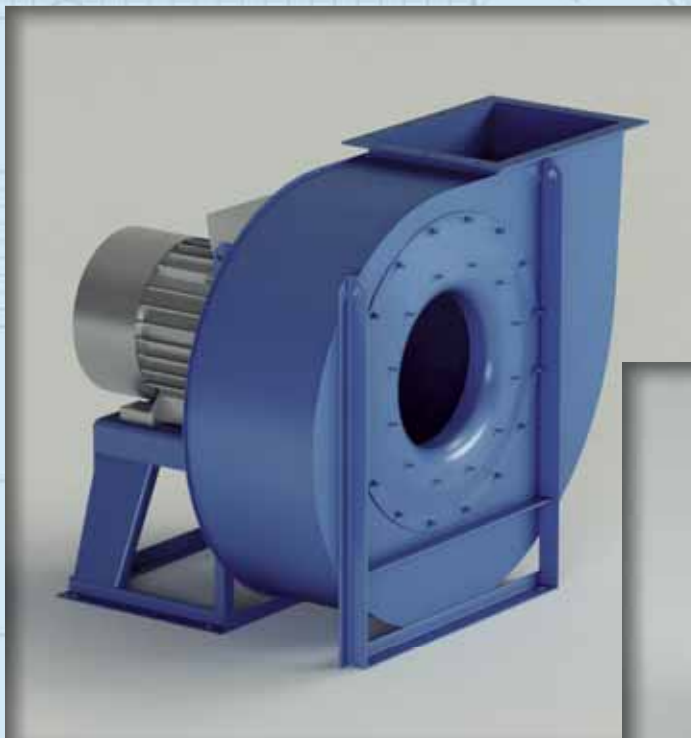

$Q = 360 \div 180000 \text{ m}^3/\text{h}$

$Q = 0.1 \div 50 \text{ m}^3/\text{s}$

$p_t = 50 \div 560 \text{ mmH}_2\text{O}$

$p_t = 500 \div 5500 \text{ Pa}$



PRM

Campo di lavoro

Portate basse-medie-alte. Pressioni basse-medie.

Tipo di pala

Curva, rovescia (negativa), vedi pag. 2.2.

Applicazioni

Per aspirazione e trasporto di aria anche molto polverosa, segatura, trucioli vari, materiali granulari, ad esclusione di materiali filamentosi.

Esecuzioni costruttive standard

Es.1-Es.4-Es.5-Es.8-Es.9-Es.12, vedi pag. 2.5 - 2.6.

Temperature del fluido standard

-10÷+60°C. Per altre temperature vedi da pag. 1.12 a pag. 1.15.

Tipo di costruzione

Ventilatore in lamiera di Fe360, girante in Fe360 equilibrata staticamente e dinamicamente. Per altri materiali vedi da pag. 1.12 a pag. 1.15.

Dati di funzionamento

Condizioni dell'aria all'aspirazione T=20°C, 0m.s.l.m. e ρ=1.205 kg/m³.

Rumorosità

Espressa in potenza sonora L_{wA} [dB(A)] rilevata in campo libero con ventilatore canalizzato, vedi da pag. 1.43 a pag. 1.49.

Orientamenti

N°8 RD (rotazione oraria vista lato trasmissione) e N°8 LG. Ventilatore in versione imbullonata orientabile per le taglie 130-450, orientamento fisso per le taglie 500-1400. Vedi pag. 2.7.

Costruzioni speciali

Vedi da pag. 2.20 a pag. 2.30.

Classi giranti

La seguente tabella fa riferimento a condizioni di lavoro standard. In condizioni di esercizio gravose si consiglia di contattare il servizio clienti di CORAL per conoscere la tipologia di girante più idonea.

GRANDEZZA VENTILATORE • Grandeur • Size • Größe • Tamaño	RPM MASSIMO *		
	CLASSE I	CLASSE II	CLASSE III
PRM130	5200	6300	
PRM180/R	5200	6300	
PRM180	5200	6300	
PRM200/R	5000	5600	
PRM200	5000	5600	
PRM220/R	4800	5200	
PRM220	4550	5000	
PRM250/R	4350	4700	
PRM250	4150	4500	
PRM280/R	3950	4250	
PRM280	3750	4000	
PRM320/R	3550	3800	
PRM320	3350	3600	
PRM360/R	3250	3500	
PRM360	3150	3400	
PRM400/R	3050	3250	3550
PRM400	2950	3150	3300
PRM450/R	2600	2950	3200
PRM450	2400	2800	3050
PRM500/R	2250	2700	2950
PRM500	2100	2500	2750
PRM560/R	2000	2400	2600
PRM560	1900	2200	2400
PRM630/R	1750	2100	2300
PRM630	1650	2000	2200
PRM700/R	1550	1850	2050
PRM700	1450	1700	1900
PRM800/R	1350	1600	1750
PRM800	1250	1500	1650
PRM900/R	1150	1350	1550
PRM900	1050	1250	1450
PRM1000/R	1000	1200	1350
PRM1000	950	1150	1300
PRM1100	900	1050	1200
PRM1250	950	1050	1150
PRM1400	850	950	1050

FRA	60°C	E	100°C	DECLASSARE VELOCITÀ	4%
	• entre		100°C		• et
• between	150°C	• and	200°C	• degrade speed	16%
• zwischen	200°C	• und	250°C	• Geschwindigkeit herabsetzen	23%
• entre	250°C	• y	300°C	• rebajar velocidad	30%
	300°C		350°C		37%
	350°C		400°C		45%
	400°C		450°C		54%
	450°C		500°C		64%

* VALORI VALIDI FINO A 60°C

• Valeurs valables jusqu'à 60°C • Values valid up to 60°C
• Werte bis 60°C gültig • Valores válidos hasta 60°C

■ Domaine de travail

Débits petits-moyens-élevés. Basses-moyennes pressions.

Type d'ailette

Courbée, inversée (négative), voir page 2.2.

Applications

Pour aspiration et transport d'air très poussiéreux, de sciure, de divers copeaux, de matières en granulés, sauf matières filamenteuses.

Configurations de constructions standard

Ex.1- Ex.4- Ex.5- Ex.8- Ex.9- Ex.12, voir pages 2.5 - 2.6.

Températures du fluide standard

-10÷+60°C. Pour d'autres températures voir pages 1.12-1.15.

Type de fabrication

Ventilateur en tôle de Fe360, turbine en Fe360 équilibrée statiquement et dynamiquement. Pour d'autres matériaux, voir pages 1.12-1.15.

Données de fonctionnement

Conditions de l'air à l'aspiration T=20°C, 0 m asl et ρ=1.205 kg/m³.

Niveau sonore

Exprimé en puissance sonore L_{wA} [dB(A)], relevé à l'air libre avec un ventilateur canalisé, voir pages 1.43 - 1.49.

Orientations

8 RD (rotation dans le sens des aiguilles d'une montre côté transmission) et 8 LG. Ventilateur en version boulonnée orientable pour les tailles 130-450, orientation fixe pour les tailles 500-1400. Voir page 2.7.

Fabrications spéciales

Voir pages 2.20-2.30.

Classes de turbines

Le tableau ci-dessus fait référence aux conditions de travail normales, en conditions de travail pénibles, on préconise de contacter le service clientèle de CORAL pour connaître le type de turbine le plus adapté.

■ Field of operation

Low-medium-high flow rates. Medium-low pressures.

Blade type

Curve, backward (negative), see pg. 2.2.

Applications

For the inlet and transport of potentially very dusty air, sawdust, various chips, granular materials, with the exclusion of filaments.

Standard constructional arrangements

Arr.1-Arr.4-Arr.5-Arr.8-Arr.9-Arr.12, see pgs. 2.5 - 2.6.

Standard fluid temperatures

-10÷+60°C. For other temperatures see pgs. 1.12 to 1.15.

Type of construction

Fan in Fe360 plate, impeller in Fe360 statically and dynamically balanced. For other materials see pgs. 1.12 to 1.15.

Operating specifications

Condition of inlet air T=20°C, 0 m above sea level and ρ=1.205 kg/m³.

Noise level

Expressed as sound power L_{wA} [dB(A)] measured in free field with ducted fan, see pgs. 1.43 to 1.49.

Orientations

No.8 RD (clockwise viewed from transmission side) and No.8 LG. Fan in bolted orientable version for sizes 130-450, fixed orientation for sizes 500-1400. See pg. 2.7.

Special applications

See pgs. 2.20 to 2.30.

Impeller classes

The above table refers to standard operating conditions, in heavy-duty service conditions it is advisable to contact the CORAL Customer Service to establish the most suitable type of impeller.

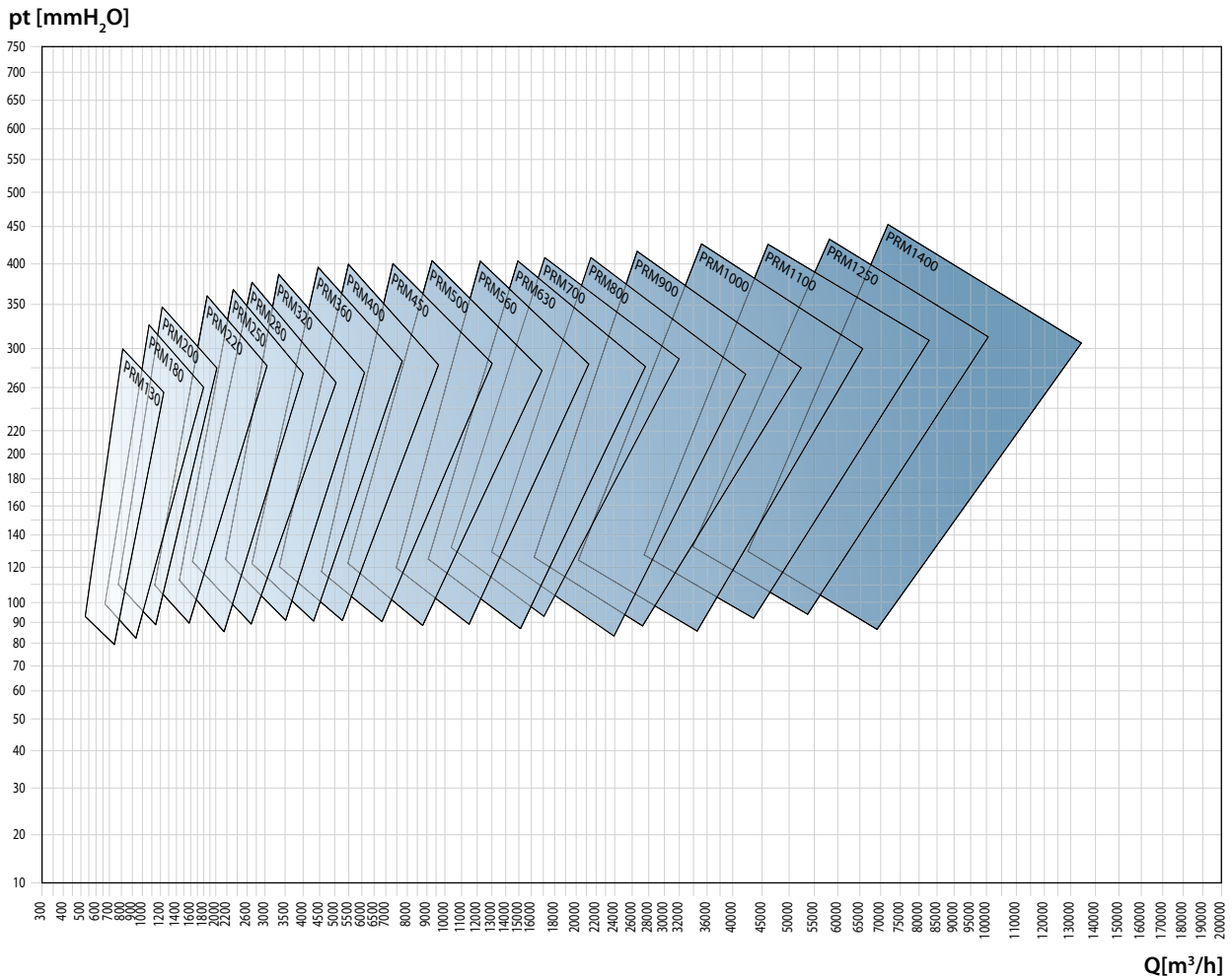

■ **Arbeitsbereich**

Niedrige - mittlere - grosse Fördermengen. Mittlere - niedrige Drücke.

Schaufelform

Kurve, rückwärts gekrümmt (negativ), siehe Seite 2.2.

Anwendungen

Zur Absaugung und zum Transport von stark staubhaltiger Luft, vermischt mit Sägestaub, Spänen verschiedener Art, Granulaten, ausser fadenförmigen Materialien.

Konstruktive Standardausführungen

Ausf. 1-Ausf. 4-Ausf. 5-Ausf. 8-Ausf. 9-Ausf. 12, siehe Seiten 2.5 - 2.6.

Standardtemperatur des Mediums

-10 ÷ +60°C. Für andere Temperaturen siehe Seiten 1.12 bis 1.15.

Konstruktionsart

Ventilator aus Blech Fe360, Laufrad aus Fe360, statisch und dynamisch ausgewuchtet. Für andere Materialien siehe Seiten 1.12 bis 1.15.

Betriebsdaten

Physikalischer Zustand der Ansaugluft T = 20°C, 0 m ü. M. und ρ = 1.205 kg/m³.

Geräuschpegel

angegeben als Schalleistungspegel L_{wA} [dB(A)] mit Messung im Freifeld und an Rohren angeschlossenem Ventilatore, siehe Seiten 1.43 bis 1.49.

Ausrichtung

8 Modelle RD (Drehrichtung im Uhrzeigersinn, von Antriebsseite aus gesehen) und 8 Modelle LG. Angeschraubter, in der Ausrichtung veränderbarer Ventilator in den Grössen 130-450, mit Vorderstütze und damit nicht veränderbar ab Grösse 500 mit Riementrieb, immer ausrichtbar bei allen direkt angetriebenen Ventilatoren ohne Vorderstütze, siehe Seite 2.7.

Spezialausführungen

Siehe Seiten 2.20 bis 2.30.

Laufradklassen

Die obenstehende Tabelle bezieht sich auf normale Betriebsbedingungen. Bei erschwerenden Betriebsbedingungen wird empfohlen, den Kundenservice von CORAL zu kontaktieren, um den am besten geeigneten Laufradtyp zu bestimmen.

■ **Campo de trabajo**

Caudales pequeños-medios-altos. Presiones medias-bajas.

Tipo de pala

Curva, invertida (negativa), ver pág. 2.2.

Aplicaciones

Para aspiración y transporte de aire incluso muy cargado de polvo, serrín, virutas de distintos tipos y materiales granulados, exceptuando los materiales filamentosos.

Variantes constructivas estándares

Ejec.1-Ejec.4-Ejec.5-Ejec.8-Ejec.9-Ejec.12, ver págs. 2.5 - 2.6.

Temperaturas del fluido estándares

De -10 a +60°C. Para otras temperaturas, ver págs. de 1.12 a 1.15.

Tipo de construcción

Ventilador de chapa en Fe360, rotor en Fe360 equilibrado estática y dinámicamente. Para otros materiales, ver págs. de 1.12 a 1.15.

Datos de funcionamiento

Condiciones del aire en aspiración T=20°C, 0 m SNM y ρ=1.205 kg/m³.

Niveles de ruido

Expresados en potencia sonora L_{wA} [dB(A)] medida en campo abierto con ventilador canalizado, ver págs. de 1.43 a 1.49.

Orientaciones

8 RD (rotación dextrógira vista desde el lado de transmisión) y 8 LG. Ventilador en versión empennada orientable para tamaños 130-450, orientación fija para tamaños 500-1400. Ver pág. 2.7.

Construcciones especiales

Ver págs. de 2.20 a 2.30.

Clases de rotores

La tabla arriba hace referencia a condiciones de trabajo estándares, en condiciones de funcionamiento pesadas, se aconseja llamar al Servicio de atención al cliente de CORAL para conocer el tipo de rotor más adecuado.

PRM

Tipo		P inst. [kW]	n	LpA [dB(A)]	Tolleranza sulla portata ±5%																			
• Type • Type • Typ • Tipo					• Tolérance sur le débit ±5% • Load tolerance ±5%																			
Ventilatore	Motore				Q [m³/h]																			
					360	400	430	470	540	650	720	790	865	935	1080	1225	1370	1440	1620	1800	2160	2520	2880	3240
• Ventilateur • Fan • Ventilator • Ventilador		pt[mmH ₂ O]																						
• Moteur • Motor • Motor • Motor																								
PRM130/2	63	0,18	2820	54	71	70	69	67	64	57	52	45												
PRM180/2R	63	0,25	2820	57			85	84	83	79	76	71	66	61	48									
PRM180/2	71	0,37	2820	59				98	96	93	91	88	85	82	72	60	44							
PRM200/2R	71	0,55	2850	61					110	109	108	106	104	102	96	88	77	72	53					
PRM200/2	80	0,75	2850	61						123	122	121	120	118	114	109	102	98	86	70				
PRM220/2R	80	1,1	2920	65									156	154	151	148	144	141	135	127	106	74		
PRM220/2	90	1,5	2920	65										166	163	159	156	154	149	143	126	101		
PRM250/2R	90	1,5	2920	63											190	190	190	189	187	180				
PRM250/2	90	2,2	2920	68												207	207	207	203	195	183	168	148	
PRM280/2R	100	3	2940	70															277	274	266	255	241	223
PRM280/2	112	4	2940	71															292	290	284	275	263	248
PRM320/2R	132	5,5	2940	74																		339	337	332
PRM320/2	132	7,5	2940	73																			356	353
PRM360/2R	160	11	2950	77																				
PRM360/2	160	15	2950	77																				
PRM400/2R	160	18,5	2960	81																				
PRM400/2	180	22	2960	81																				
PRM360/4R	90	1,1	1420	62														89	88	87	83	78	72	
PRM360/4	90	1,5	1420	64															95	94	93	90	85	
PRM400/4R	100	2,2	1420	66																	113	112	110	
PRM400/4	100	3	1420	67																	121	121	120	
PRM450/4R	112	4	1440	69																			143	
PRM450/4	132	5,5	1460	70																				
PRM500/4R	132	7,5	1460	72																				
PRM500/4	160	11	1460	74																				
PRM560/4R	160	15	1460	75																				
PRM560/4	180	18,5	1460	76																				
PRM630/4R	200	30	1465	78																				
PRM630/4	225	37	1470	78																				
PRM700/4R	225	45	1470	80																				
PRM700/4	250	55	1485	82																				
PRM800/4R	280	75	1490	83																				
PRM800/4	280	90	1490	84																				
PRM560/6R	132	4	955	66																				
PRM560/6	132	5,5	960	68																				
PRM630/6R	160	7,5	970	70																				
PRM630/6	160	11	970	71																				
PRM700/6R	180	15	980	73																				
PRM700/6	200	18,5	985	73																				
PRM800/6R	200	22	985	74																				
PRM800/6	225	30	985	76																				
PRM900/6R	250	37	990	78																				
PRM900/6	280	45	990	78																				
PRM1000/6R	280	55	990	80																				
PRM1000/6	315	75	995	81																				

Il livello di pressione sonora ponderato A, LpA (cap.14), corrisponde al valore rilevato, nelle condizioni di prova, nel punto di massima rumorosità.

Tolleranza sulla rumorosità ±4dB(A)

- Tolérance sur le bruit ±4dB(A) • Noise tolerance ±4dB(A)
- Geräushtoleranz ±4dB(A) • Tolerancia respecto a ruido ±4dB(A)

Q [m³/h]																												
3960	4320	4680	5400	6120	7200	7920	9000	10080	10800	12600	14400	16200	18000	19800	21600	25200	28800	32400	36000	39600	43200	46800	54000	61200	68400	76500	86400	
pt[mmH₂O]																												
124																												
204	183	160	112																									
232	212	191	146	98																								
325	315	303	274	238	176	129																						
347	338	328	302	270	210	168																						
380	380	378	369	353	320	292	242	187	147																			
	412	412	408	399	375	353	313	266	231																			
			486	488	483	473	452	422	399	329	247	157																
				523	524	520	507	485	467	410	340	259																
64	55	47																										
80	73	65	48																									
108	104	99	89	75	52																							
119	116	113	104	91	73	56																						
143	142	140	135	128	113	101	81	60																				
	163	163	160	155	145	135	119	101	87																			
			187	187	182	176	165	151	140	110	78																	
				210	210	208	202	192	185	162	134	104	74															
					251	250	247	243	230	212	190	165	138	110														
						271	270	268	260	246	228	208	184	158	103													
								329	329	325	316	305	290	273	231	184	134											
									354	354	349	341	330	316	261	239	193											
											404	402	398	390	369	340	304	264	220	175								
												448	450	449	445	431	410	381	348	310	269	226						
													511	512	509	498	480	457	429	396	360	281	198					
															571	570	561	540	530	507	480	416	347	265				
		107	108	107	104	101	92	84	77	62	43																	
			117	117	116	114	108	103	98	85	65	48																
				145	145	144	142	139	130	117	103	90	76	61														
					156	156	153	151	147	133	125	110	98	80														
							180	180	178	173	167	157	143	136	107	76												
								196	197	195	191	185	176	168	146	117	89											
									224	223	220	215	211	193	170	148	115	95										
										250	250	248	245	235	220	201	178	155	129	103								
												287	286	282	274	261	246	228	207	185	138							
													315	315	311	304	293	280	264	246	205	160						
																351	349	344	335	325	312	280	242	200	151			
																	399	399	396	390	383	361	314	301	259	203		

■ Le niveau de pression sonore pondérée A, LpA (chap. 14), correspond à la valeur relevée dans les conditions d'essai au point de niveau sonore maximum.
 ■ Der nach A bewertete Schalldruckpegel LpA (Kap. 14) entspricht in den Testbedingungen dem höchsten gemessenen Wert des Geräuschpegels.

■ The A-weighted sound power level, LpA (Chap.14), is the value measured in test conditions at the point of maximum noise level.
 ■ El nivel de presión sonora ponderado A, LpA (cap. 14), corresponde al valor medido, en las condiciones de prueba, en el punto con máximos niveles de ruido.

PRM

Tipo • Type • Type • Typ • Tipo	Motore • Moteur • Motor • Motor • Motor	P inst. [kW]	n	LpA [dB(A)]	Tolleranza sulla portata ±5% • Tolérance sur le débit ±5% • Load tolerance ±5% • Durchsatztoleranz ±5% • Tolerancia respecto caudal ±5%																				
					Q [m³/h]																				
					360	400	430	470	540	650	720	790	865	935	1080	1225	1370	1440	1620	1800	2160	2520	2880	3240	3600
					pt[mmH ₂ O]																				
PRM130/2	63	0,18	2820	54	70	69	68	66	63	56	51	44													
PRM180/2R	63	0,25	2820	57			85	84	83	79	76	72	67	62	50										
PRM180/2	71	0,37	2820	59				97	96	93	91	88	86	83	73	62	47								
PRM200/2R	71	0,55	2850	61					109	108	108	106	104	102	97	89	79	74	56						
PRM200/2	80	0,75	2850	61						122	121	120	120	118	114	110	103	100	88	73					
PRM220/2R	80	1,1	2920	65									154	152	150	147	144	141	135	128	109	79			
PRM220/2	90	1,5	2920	65										164	161	158	155	153	149	144	128	105			
PRM250/2R	90	1,5	2920	63											187	188	188	187	185	179					
PRM250/2	90	2,2	2920	68												204	204	205	202	195	184	169	152		
PRM280/2R	100	3	2940	70														271	269	262	252	239	223		
PRM280/2	112	4	2940	71															285	284	279	271	260	247	
PRM320/2R	132	5,5	2940	74																		330	329	324	
PRM320/2	132	7,5	2940	73																			346	344	
PRM360/2R	160	11	2950	77																					
PRM360/2	160	15	2950	77																					
PRM400/2R	160	18,5	2960	81																					
PRM400/2	180	22	2960	81																					
PRM360/4R	90	1,1	1420	62													89	88	87	83	79	73			
PRM360/4	90	1,5	1420	64														95	94	93	90	86			
PRM400/4R	100	2,2	1420	66																	112	112	110		
PRM400/4	100	3	1420	67																	120	120	120		
PRM450/4R	112	4	1440	69																			142		
PRM450/4	132	5,5	1460	70																					
PRM500/4R	132	7,5	1460	72																					
PRM500/4	160	11	1460	74																					
PRM560/4R	160	15	1460	75																					
PRM560/4	180	18,5	1460	76																					
PRM630/4R	200	30	1465	78																					
PRM630/4	225	37	1470	78																					
PRM700/4R	225	45	1470	80																					
PRM700/4	250	55	1485	82																					
PRM800/4R	280	75	1490	83																					
PRM800/4	280	90	1490	84																					
PRM560/6R	132	4	955	66																					
PRM560/6	132	5,5	960	68																					
PRM630/6R	160	7,5	970	70																					
PRM630/6	160	11	970	71																					
PRM700/6R	180	15	980	73																					
PRM700/6	200	18,5	985	73																					
PRM800/6R	200	22	985	74																					
PRM800/6	225	30	985	76																					
PRM900/6R	250	37	990	78																					
PRM900/6	280	45	990	78																					
PRM1000/6R	280	55	990	80																					
PRM1000/6	315	75	995	81																					

Il livello di pressione sonora ponderato A, LpA (cap.14), corrisponde al valore rilevato, nelle condizioni di prova, nel punto di massima rumorosità.

Tolleranza sulla rumorosità ±4dB(A)

• Tolérance sur le bruit ±4dB(A) • Noise tolerance ±4dB(A)
 • Geräuschtoleranz ±4dB(A) • Tolerancia respecto a ruido ±4dB(A)

Q [m³/h]

pt[mmH₂O]

3960	4320	4680	5400	6120	7200	7920	9000	10080	10800	12600	14400	16200	18000	19800	21600	25200	28800	32400	36000	39600	43200	46800	54000	61200	68400	76500	86400	
130																												
205	186	165	120																									
232	214	195	153	109																								
318	310	299	273	240	183	140																						
339	331	323	300	271	216	178																						
369	369	368	360	346	317	292	247	196	159																			
	399	399	396	389	369	350	314	272	240																			
			467	469	466	458	440	414	394	331	257	173																
				501	503	500	490	472	456	407	345	272																
65	57	49																										
81	75	67	51																									
108	104	100	90	77	55																							
119	116	113	105	93	76	60																						
142	141	139	134	128	114	103	84	64																				
	161	161	159	154	145	136	121	104	91																			
			185	185	181	175	165	152	142	114	84																	
				207	208	206	201	192	185	165	139	111	83															
					246	246	243	240	228	212	192	169	144	118														
						266	265	264	257	245	229	211	189	165	115													
								320	321	318	310	301	287	272	234	191	145											
									344	345	341	335	325	313	263	244	203											
										391	390	387	380	362	336	304	268	227	186									
										432	434	434	431	419	401	376	347	313	277	238								
											489	490	488	479	464	444	420	391	359	287	211							
													545	545	538	520	512	493	470	414	354	280						
		106	107	107	104	101	93	85	79	65	47																	
			116	116	116	114	109	104	99	87	69	53																
				144	144	143	141	139	130	118	105	93	80	66														
					154	155	152	150	147	134	127	113	102	85														
							178	178	176	172	166	157	144	138	110	81												
								193	195	193	190	184	176	169	149	122	96											
									220	219	217	212	209	192	171	150	119	101										
										245	246	244	241	233	219	202	181	160	135	111								
											280	280	276	269	258	244	227	208	188	144								
												307	308	304	298	289	277	263	246	209	167							
														341	340	336	328	319	307	279	244	205	160					
																386	387	385	380	374	355	312	302	264	213			

■ Le niveau de pression sonore pondérée A, LpA (chap. 14), correspond à la valeur relevée dans les conditions d'essai au point de niveau sonore maximum.

■ Der nach A bewertete Schalldruckpegel LpA (Kap. 14) entspricht in den Testbedingungen dem höchsten gemessenen Wert des Geräuschpegels.

■ The A-weighted sound power level, LpA (Chap.14), is the value measured in test conditions at the point of maximum noise level.

■ El nivel de presión sonora ponderado A, LpA (cap. 14), corresponde al valor medido, en las condiciones de prueba, en el punto con máximos niveles de ruido.

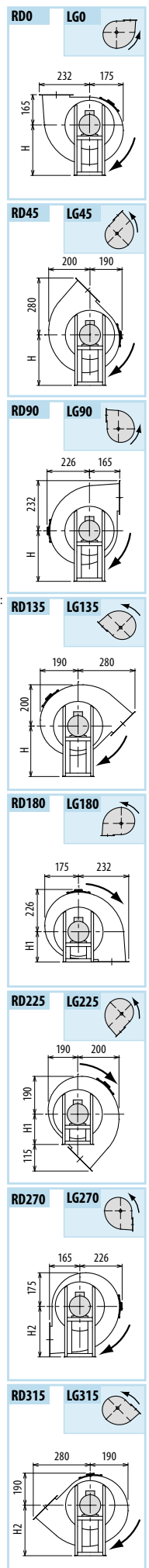
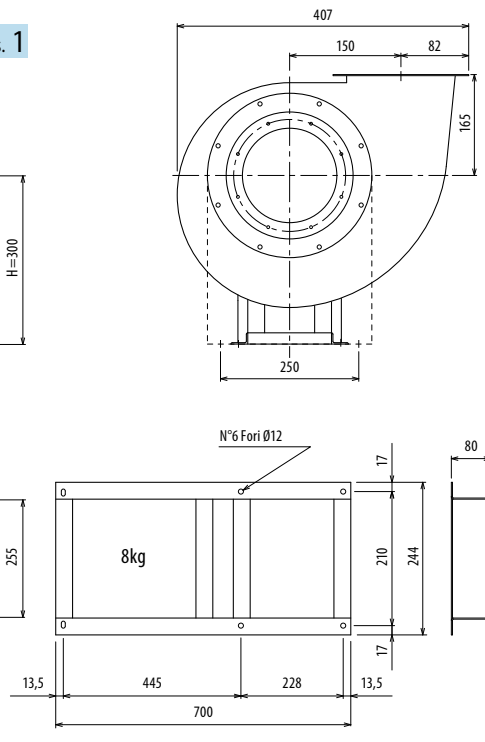
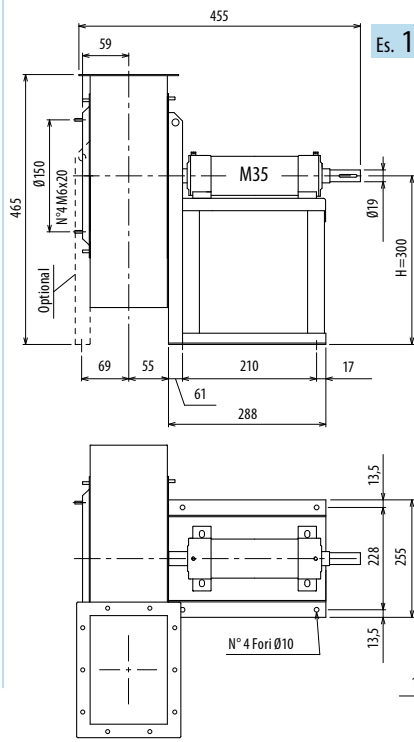
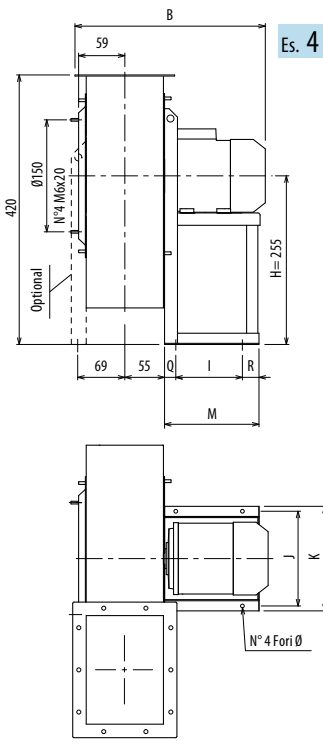

Il ventilatore è orientabile - Peso in tabella comprensivo di motore

- Le ventilateur est orientable
 - The fan is revolvable
 - Der Ventilator ist drehbar
 - El ventilador es orientable
- Le poids dans le tableau inclut le moteur The weight indicated in the table includes motor Gewichtsangabe in Tabelle inkl. Motor El peso en la tabla incluye el motor

Ulteriori informazioni e quote:

- Ulérieures informations et cotes:
- Further information and sizes:
- Weitere Infos und Größen:
- Más informaciones y medidas:

TIPO - Type		PESO Weight Kg	PD ² Kgf x m ²	B	I	H	H1	H2	J	K	M	Q	R	Ø
VENTILATORE Fan	MOTORE Motor													
PRM130/2	63 A2	18	0,08	307	86	255	165	255	184	206	150	48	16	10
PRM130/T		20	0,08			300	180	300						

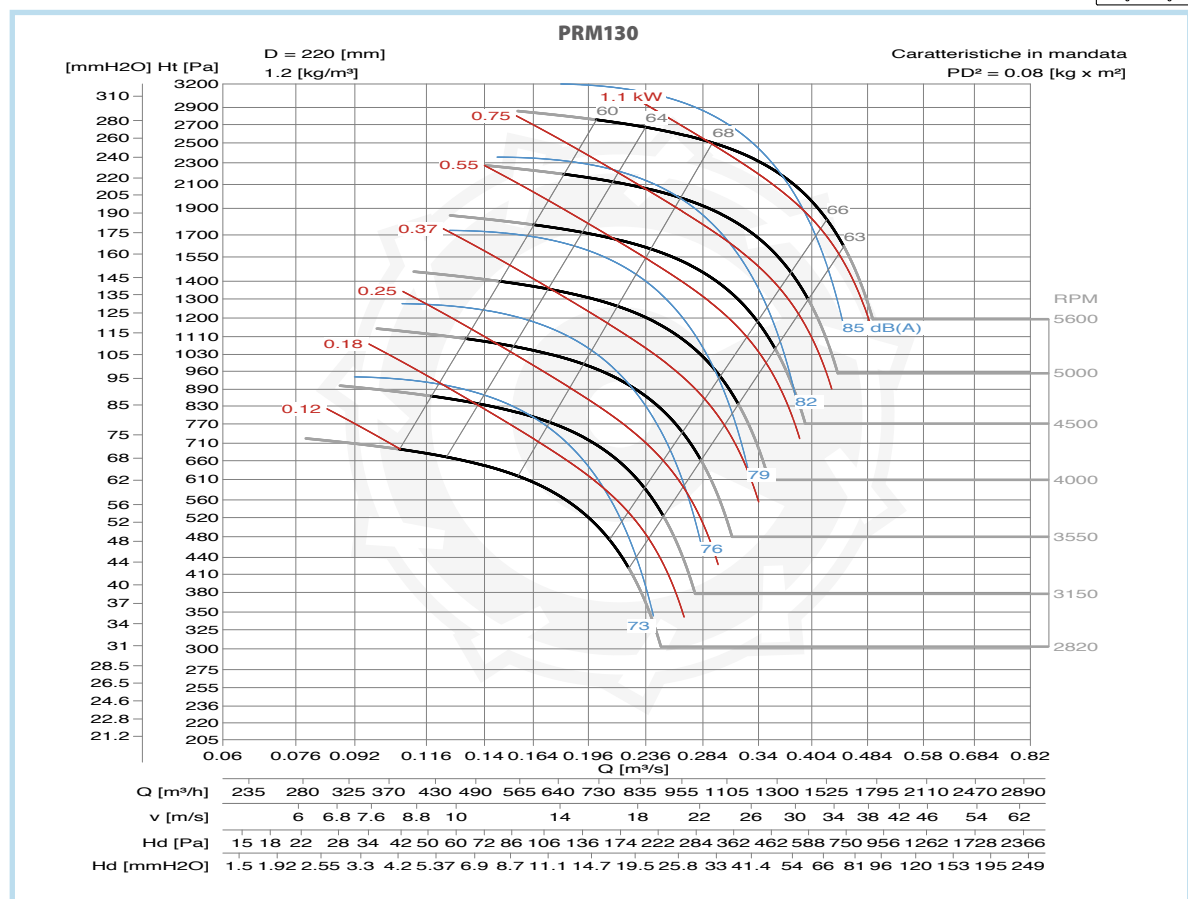
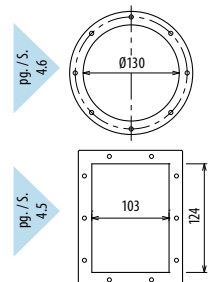

DIMENSIONI D'INGOMBRO E PESI/CURVE DI FUNZIONAMENTO

■ DIMENSIONS D'ENCOMBREMENT ET POIDS/COURBES DE FONCTIONNEMENT ■ OVERALL DIMENSIONS AND WEIGHT/WORKING CURVES
 ■ AUSMAßE UND GEWICHTE/FUNKTIONSKURVEN ■ DIMENSIONES QUE OCUPA Y PESOS/CURVAS DE FUNCIONAMIENTO

PRM180

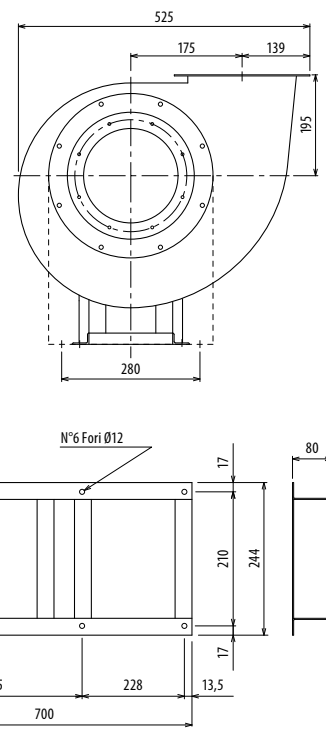
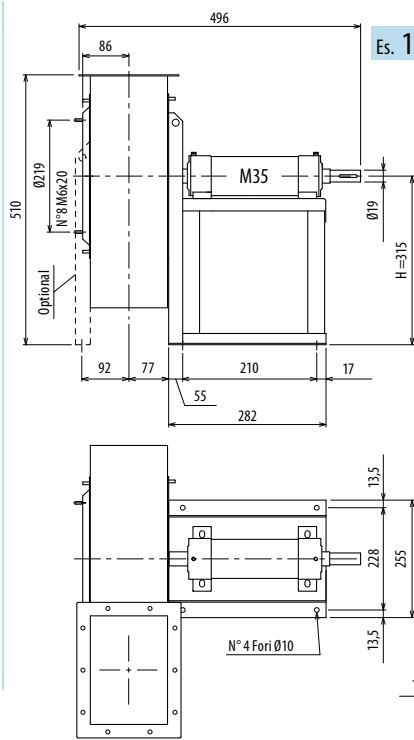
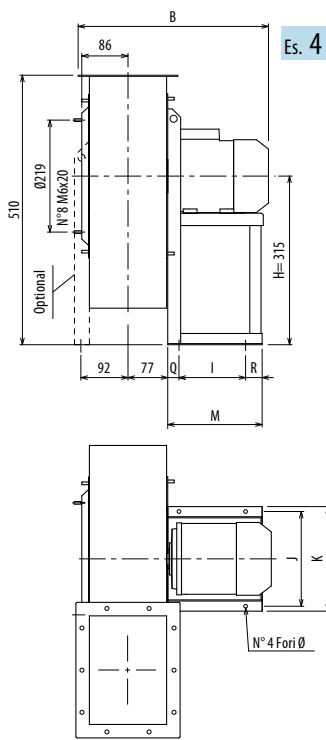

Il ventilatore è orientabile • Peso in tabella comprensivo di motore

- Le ventilatore est orientable
- The fan is revolvable
- Der Ventilator ist drehbar
- El ventilador es orientable
- Further information and notes:
- Weitere Infos und Größen:
- Más informaciones y medidas:

TIPO - Type		PESO Weight Kg	PD ² Kg x m ²	B	I	H	H1	H2	J	K	M	Q	R	Ø
VENTILATORE Fan	MOTORE Motor													
PRM180/2R	63 B2	24	0,09	366	86	315	195	315	184	206	150	48	16	10
PRM180/2	71 A2	26	0,10	396	121	315	195	315	203	225	195	48	26	10
PRM180/T		25	0,10			315	195	315						

Ulteriori informazioni e quote:
 ■ Ulérieures informations et cotes:
 ■ Further information and sizes:
 ■ Weitere Infos und Größen:
 ■ Más informaciones y medidas:

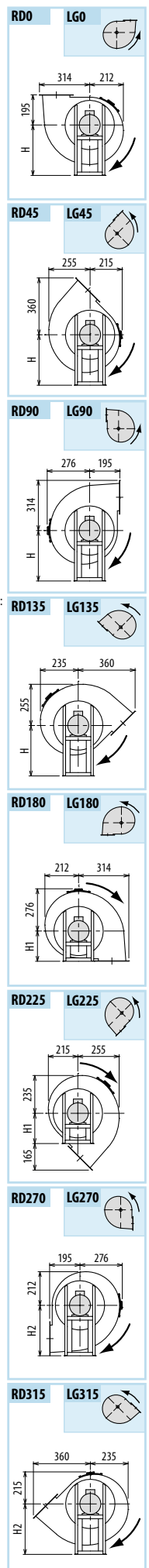
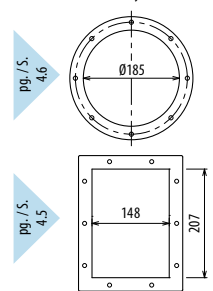

PRM

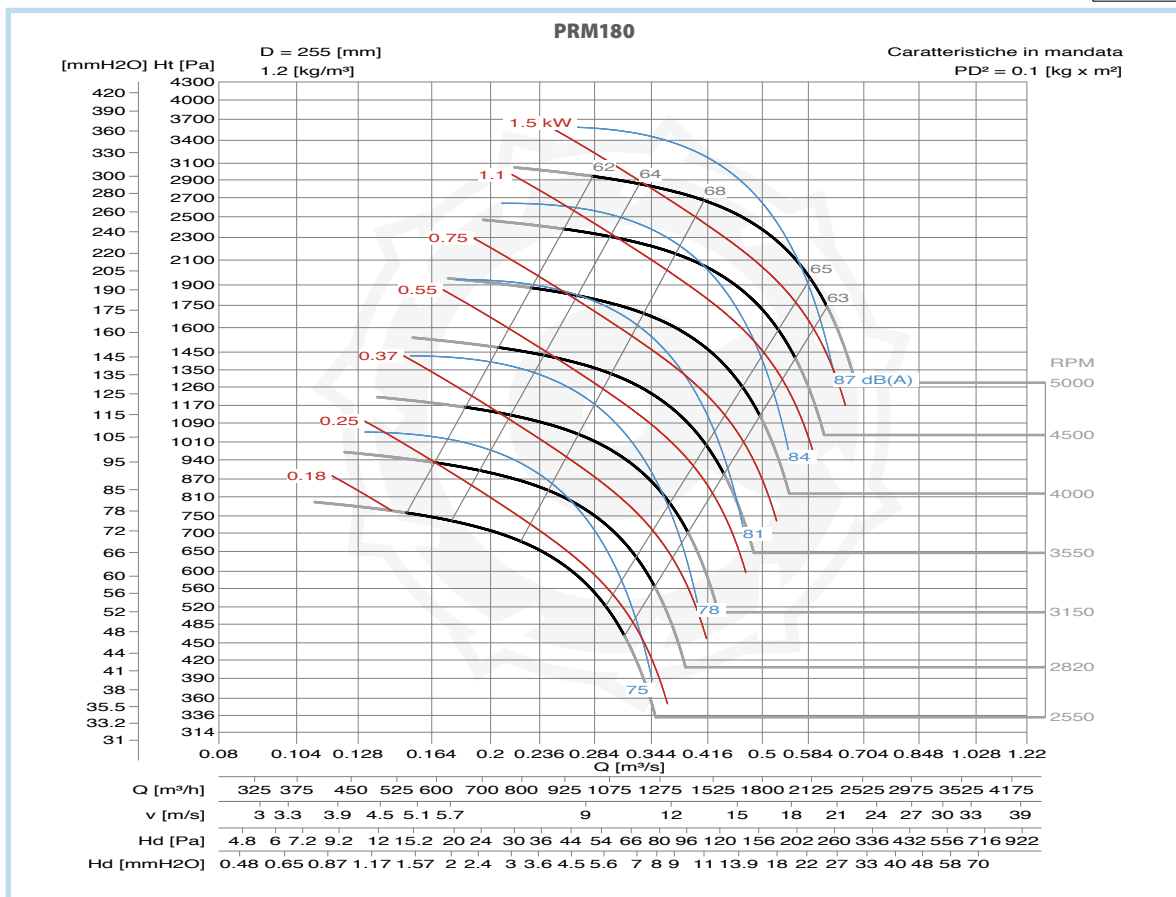

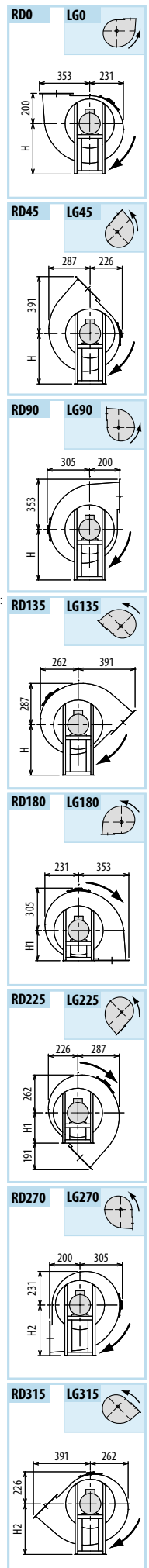
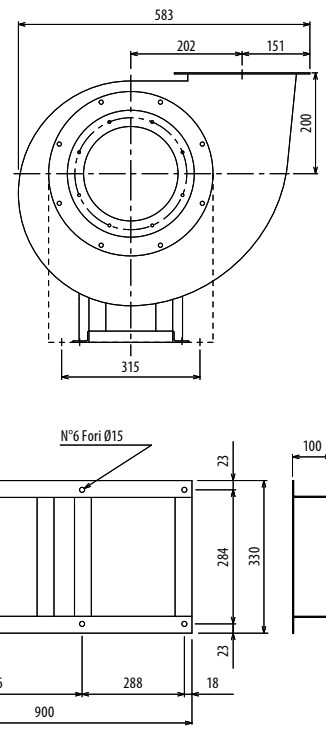
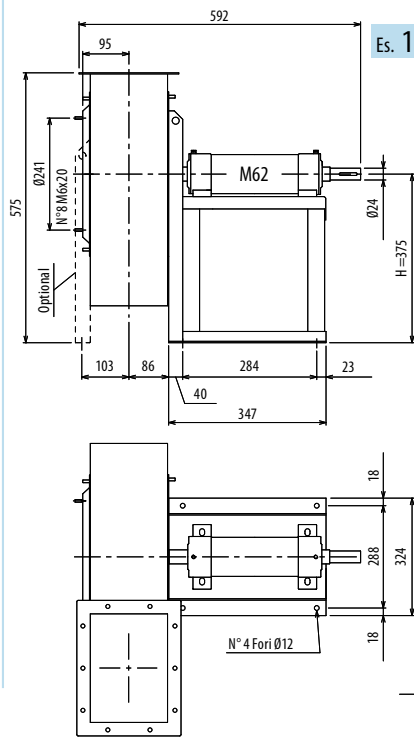
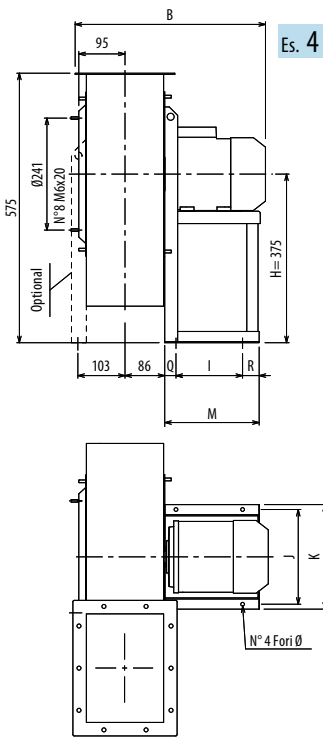

Il ventilatore è orientabile - Peso in tabella comprensivo di motore

- Le ventilateur est orientable
 - The fan is revolvable
 - Der Ventilator ist drehbar
 - El ventilador es orientable
- Le poids dans le tableau inclut le moteur The weight indicated in the table includes motor Gewichtsangabe in Tabelle inkl. Motor El peso en la tabla incluye el motor

Ulteriori informazioni e quote:
 ■ Ulérieures informations et cotes:
 ■ Further information and sizes:
 ■ Weitere Infos und Größen:
 ■ Más informaciones y medidas:

TIPO - Type		PESO Weight	PD ² Kg x m ²	B	I	H	H1	H2	J	K	M	Q	R	Ø
VENTILATORE Fan	MOTORE Motor													
PRM200/2R	71 B2	30	0,15	414	121	375	200	375	203	225	196	49	26	10
PRM200/2	80 A2	35	0,16	438	121	375	200	375	203	225	217	48	48	10
PRM200/T		40	0,16			375	200	375						

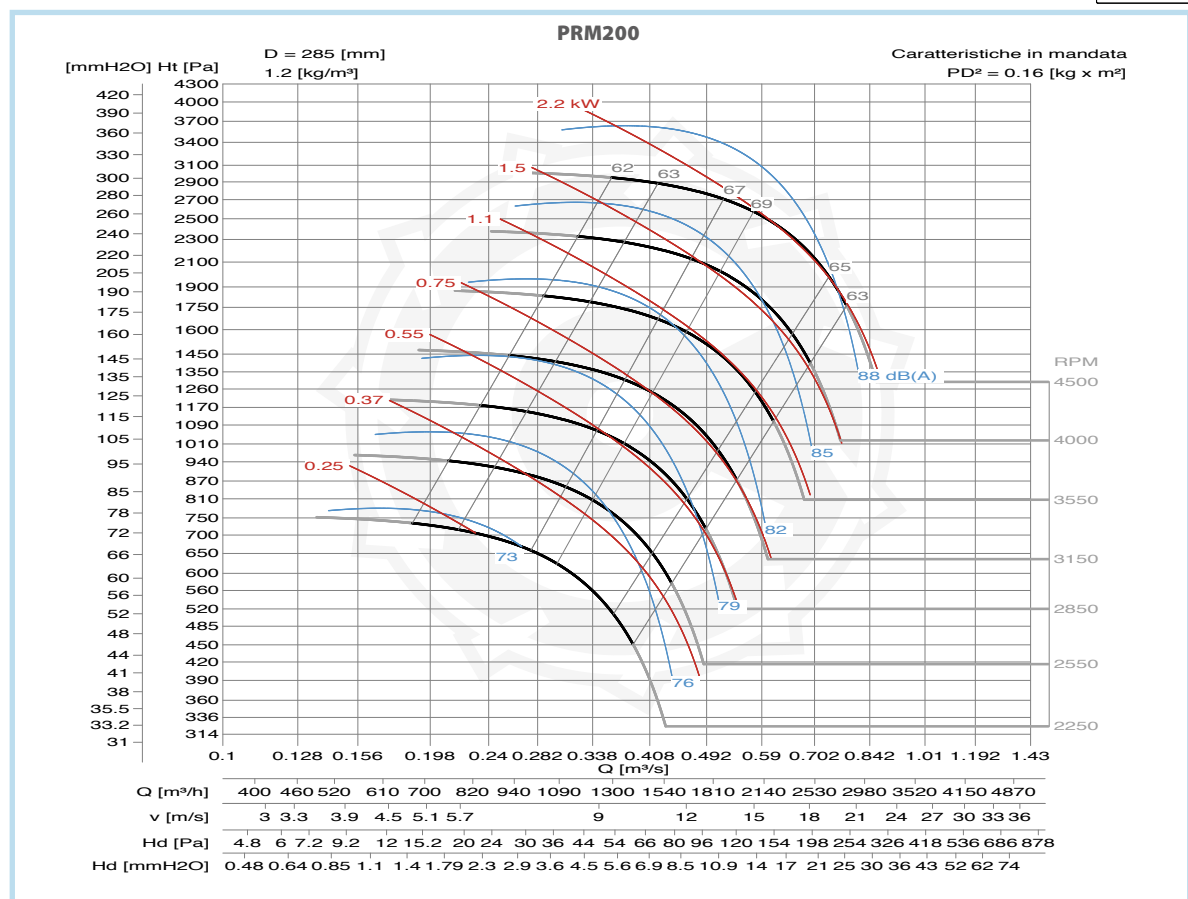
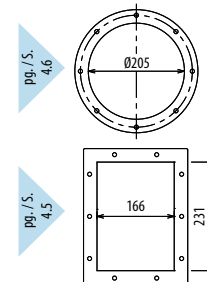

DIMENSIONI D'INGOMBRO E PESI/CURVE DI FUNZIONAMENTO

■ DIMENSIONS D'ENCOMBREMENT ET POIDS/COURBES DE FONCTIONNEMENT ■ OVERALL DIMENSIONS AND WEIGHT/WORKING CURVES
 ■ AUSMAßE UND GEWICHTE/FUNKTIONSKURVEN ■ DIMENSIONES QUE OCUPA Y PESOS/CURVAS DE FUNCIONAMIENTO

PRM220

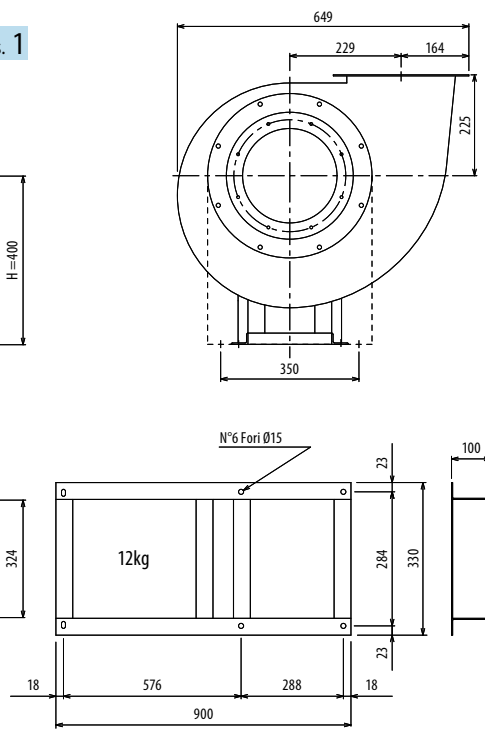
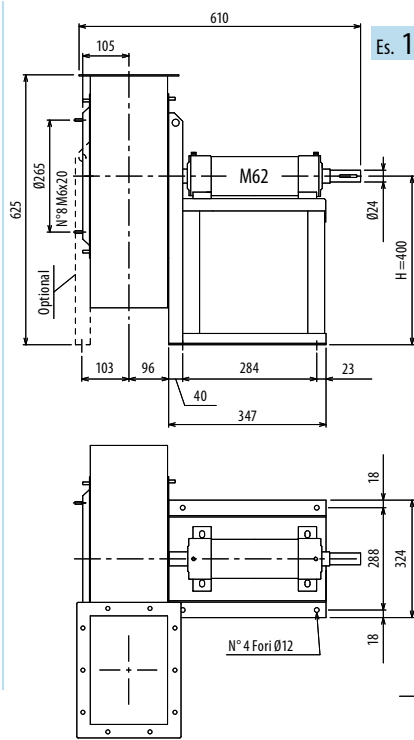
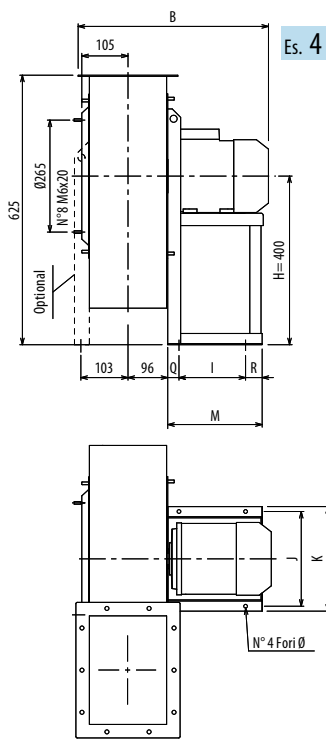

Il ventilatore è orientabile • Peso in tabella comprensivo di motore

- Le ventilateur est orientable
- The fan is revolvable
- Der Ventilator ist drehbar
- El ventilador es orientable
- Further information and notes:
- Weitere Infos und Größen:
- Más informaciones y medidas:

TIPO - Type		PESO Weight	PD ²											
VENTILATORE Fan	MOTORE Motor	Kg	Kgf x m ²	B	I	H	H1	H2	J	K	M	Q	R	Ø
PRM220/2R	80 B2	42	0,19	458	121	400	225	400	203	225	211	45	45	10
PRM220/2	90 S2	45	0,21	505	133	400	225	400	234	260	246	55	58	10
PRM220/T		45	0,21			400	225	400						

Ulteriori informazioni e quote:
 ■ Utérieures informations et cotes:
 ■ Further information and sizes:
 ■ Weitere Infos und Größen:
 ■ Más informaciones y medidas:

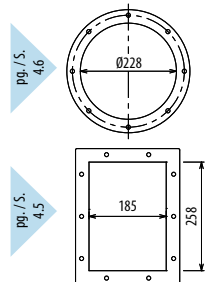

RD0 LG0

RD45 LG45

RD90 LG90

RD135 LG135

RD180 LG180

RD225 LG225

RD270 LG270

RD315 LG315

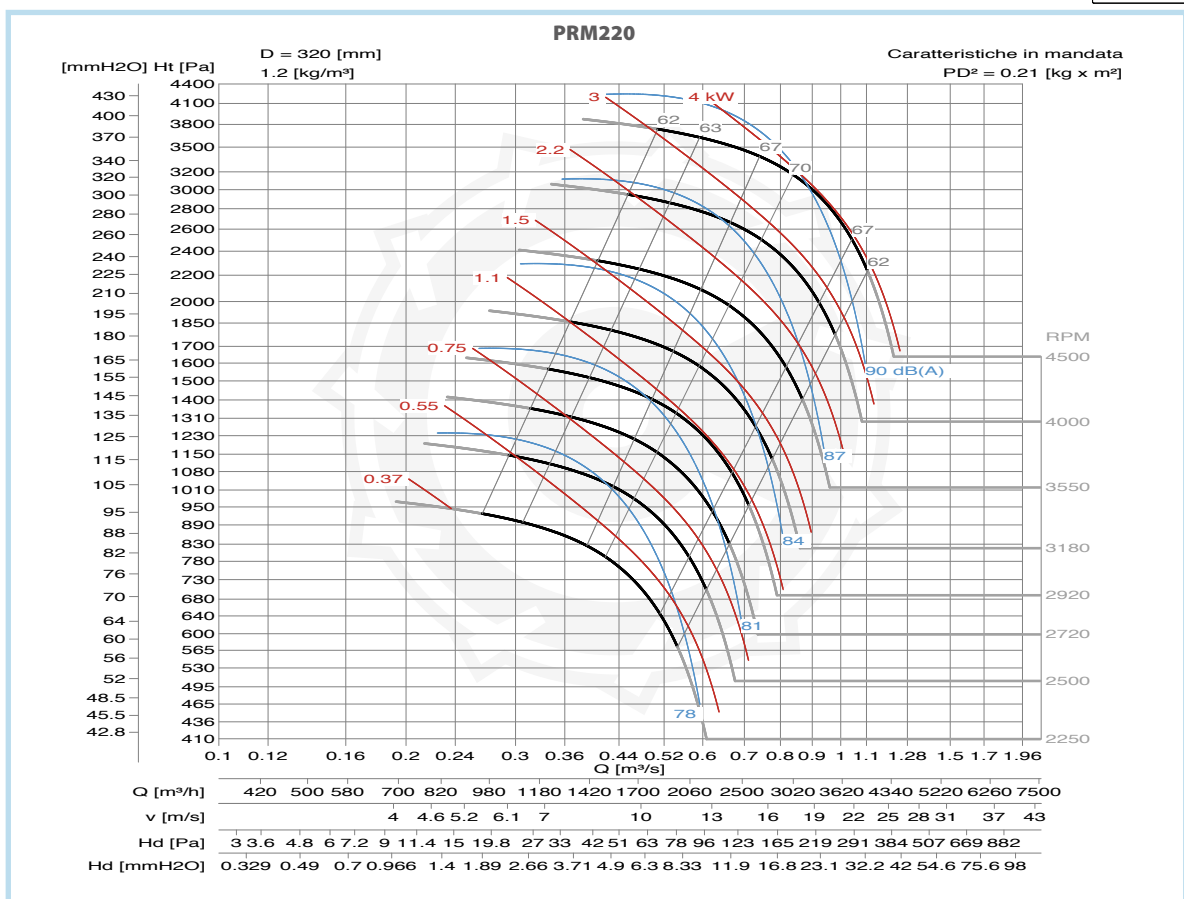

PRM

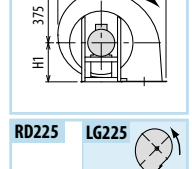
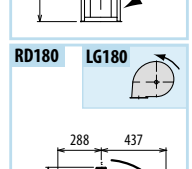
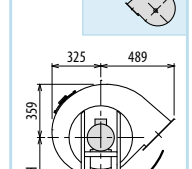
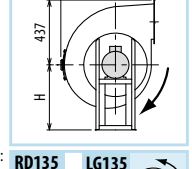
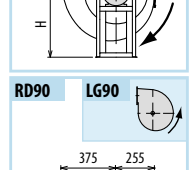
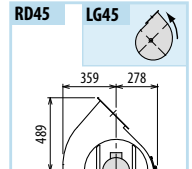
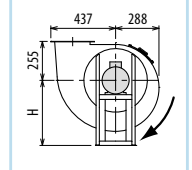
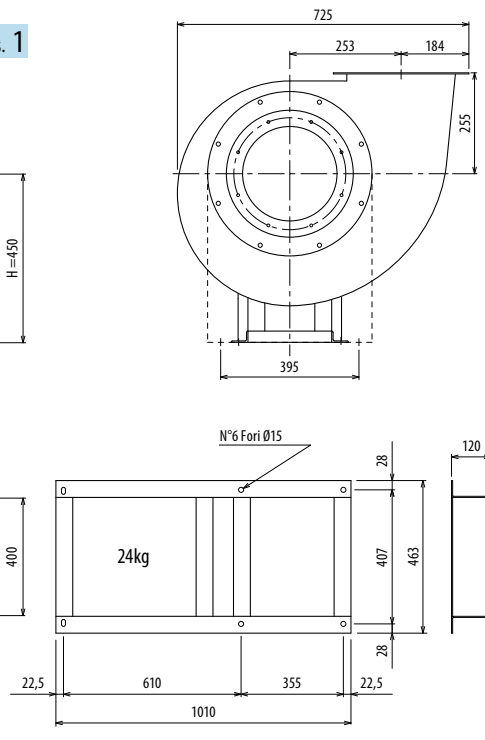
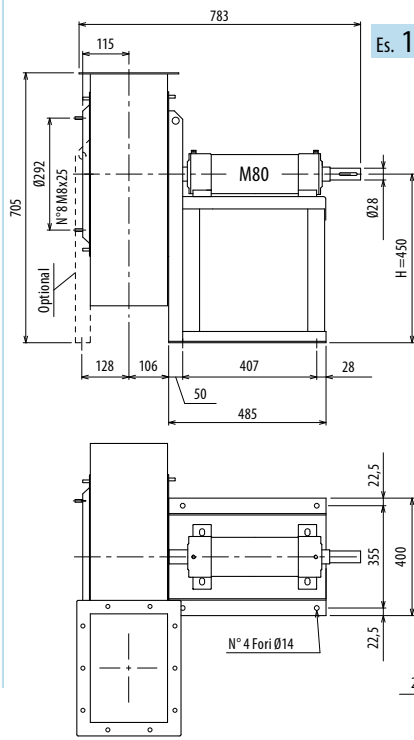
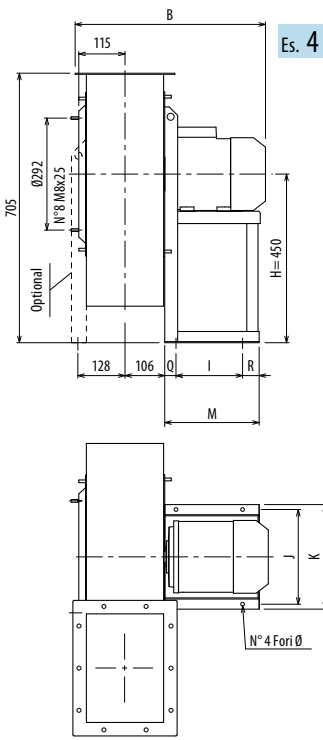

Il ventilatore è orientabile • Peso in tabella comprensivo di motore

- Le ventilateur est orientable
 - The fan is revolvable
 - Der Ventilator ist drehbar
 - El ventilador es orientable
- Le poids dans le tableau inclut le moteur The weight indicated in the table includes motor Gewichtsangabe in Tabelle inkl. Motor El peso en la tabla incluye el motor

Ulteriori informazioni e quote:

- Ulérieures informations et cotes:
- Further information and sizes:
- Weitere Infos und Größen:
- Más informaciones y medidas:

TIPO - Type		PESO Weight Kg	PD ² Kg f x m ²	B	I	H	H1	H2	J	K	M	Q	R	Ø
VENTILATORE Fan	MOTORE Motor													
PRM250/2R	90 S2	66	0,43	530	133	450	255	450	234	260	246	55	58	10
PRM250/2	90 L2	70	0,50	530	133	450	255	450	234	260	246	55	58	10
PRM250/T		75	0,50			450	255	450						

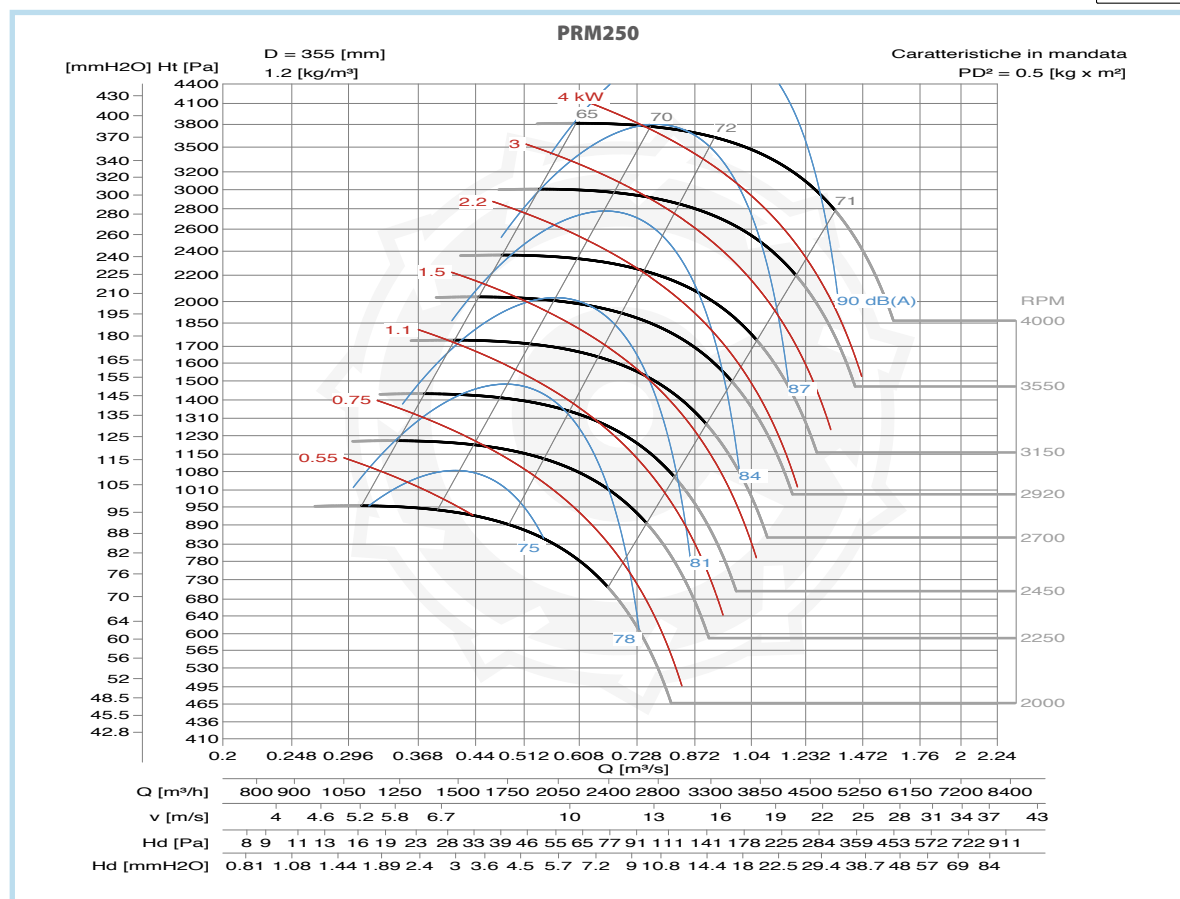
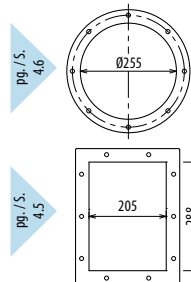

DIMENSIONI D'INGOMBRO E PESI/CURVE DI FUNZIONAMENTO

■ DIMENSIONS D'ENCOMBREMENT ET POIDS/COURBES DE FONCTIONNEMENT ■ OVERALL DIMENSIONS AND WEIGHT/WORKING CURVES
 ■ AUSMAßE UND GEWICHTE/FUNKTIONSKURVEN ■ DIMENSIONES QUE OCUPA Y PESOS/CURVAS DE FUNCIONAMIENTO

PRM280

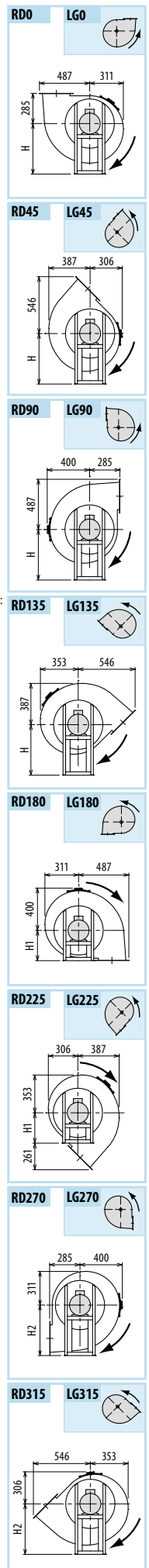
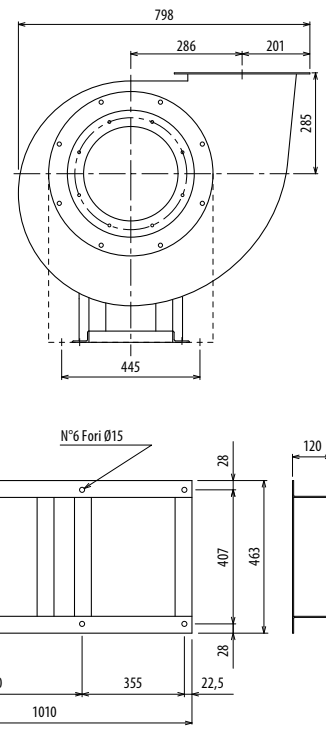
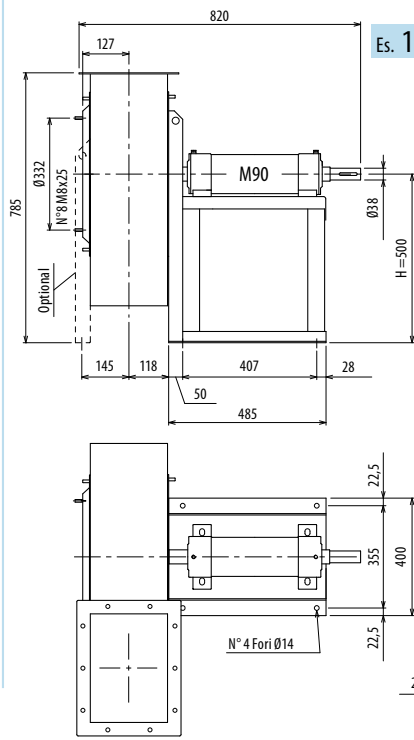
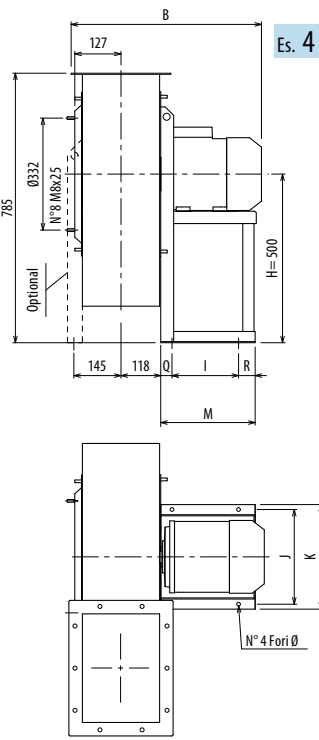

Il ventilatore è orientabile • Peso in tabella comprensivo di motore

- Le ventilateur est orientable
- The fan is revolvable
- Der Ventilator ist drehbar
- El ventilador es orientable
- Further information and notes:
- Further information and sizes:
- Weitere Infos und Größen:
- Más informaciones y medidas:

TIPO - Type		PESO Weight Kg	PD ² Kg x m ²	B	I	H	H1	H2	J	K	M	Q	R	Ø
VENTILATORE Fan	MOTORE Motor													
PRM280/2R	100 L2	85	0,70	585	197	500	285	500	289	324	276	30	49	12
PRM280/2	112 M2	93	0,80	606	197	500	285	500	289	324	276	30	49	12
PRM280/T		86	0,80			500	285	500						

Ulteriori informazioni e quote:
 ■ Ulérieures informations et cotes:
 ■ Further information and sizes:
 ■ Weitere Infos und Größen:
 ■ Más informaciones y medidas:

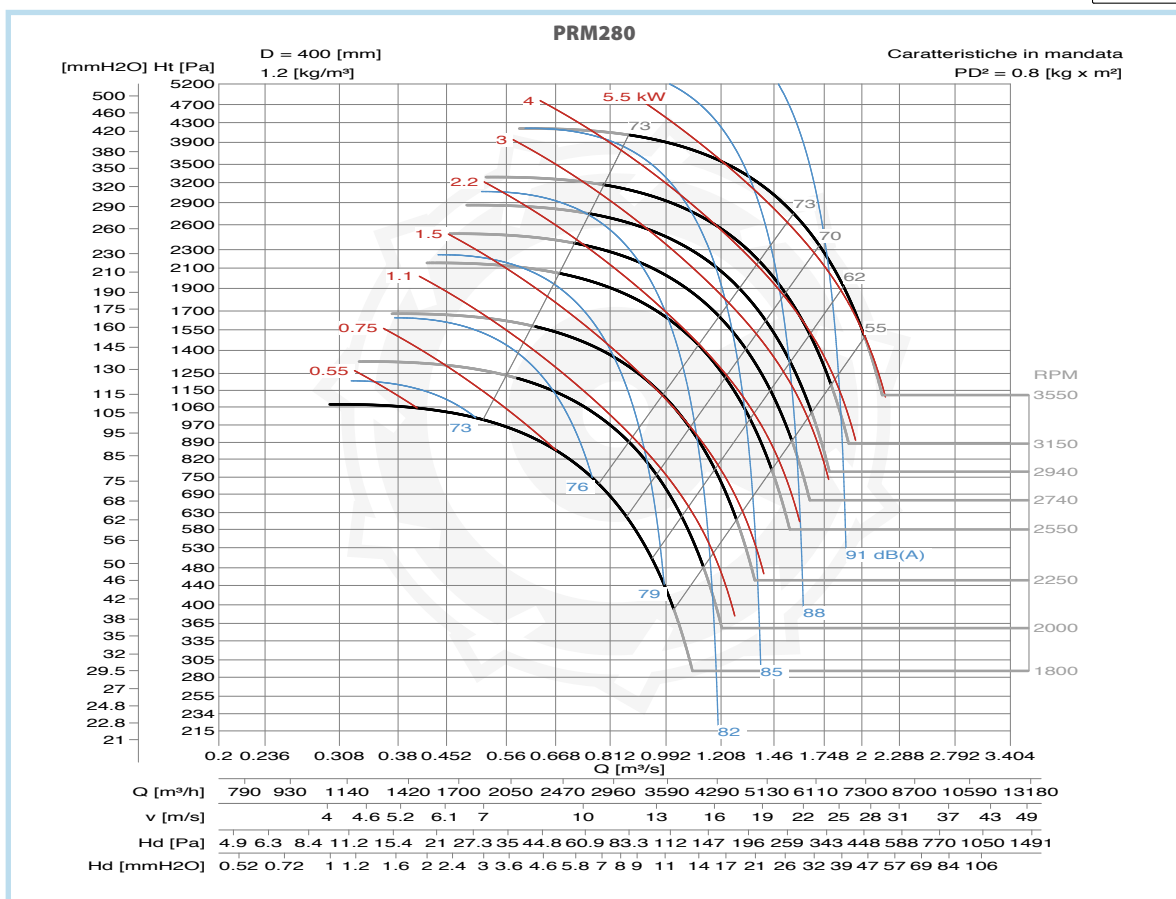
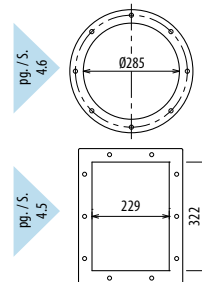

PRM

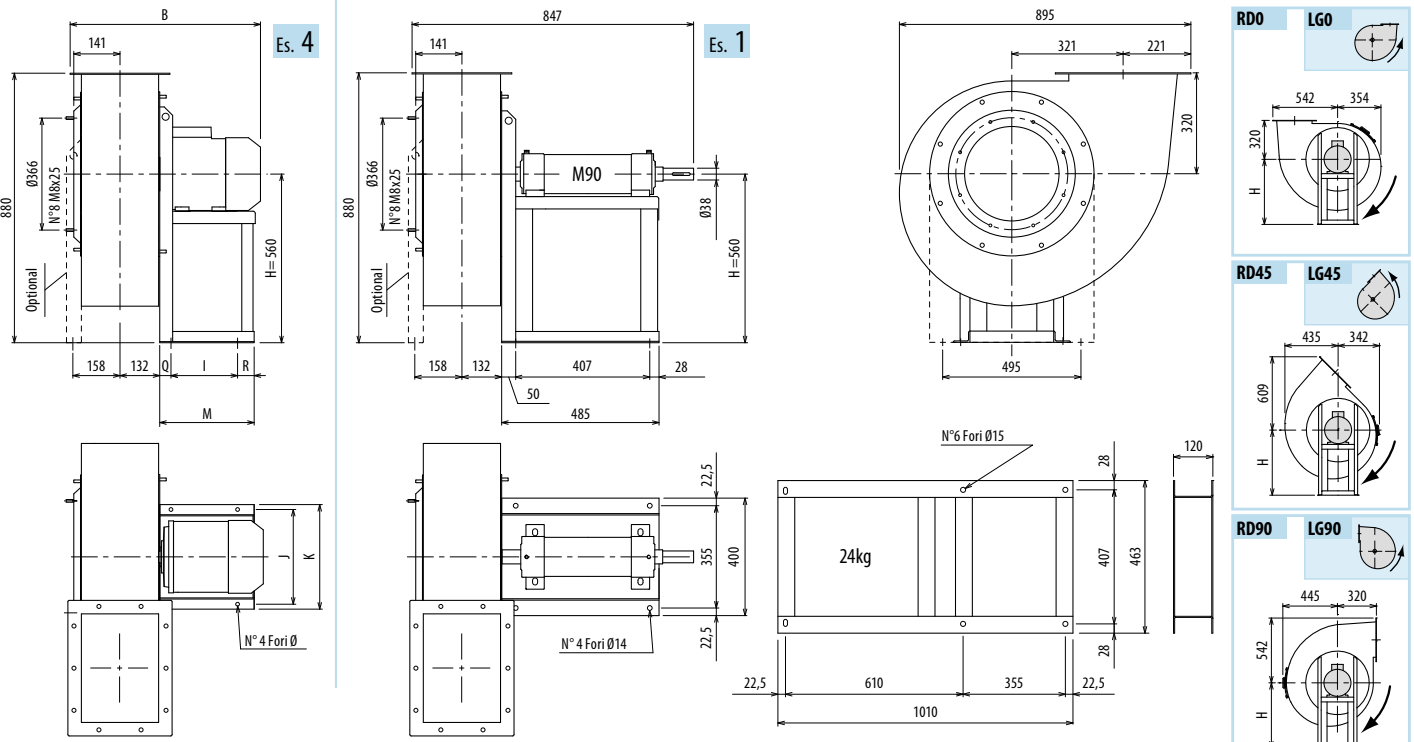

Il ventilatore è orientabile • Peso in tabella comprensivo di motore

- Le ventilateur est orientable
 - The fan is revolvable
 - Der Ventilator ist drehbar
 - El ventilador es orientable
- Le poids dans le tableau inclut le moteur
 The weight indicated in the table includes motor
 Gewichtsangabe in Tabelle inkl. Motor
 El peso en la tabla incluye el motor

Ulteriori informazioni e quote:
■ Ulérieures informations et cotes:
■ Further information and sizes:
■ Weitere Infos und Größen:
■ Más informaciones y medidas:

TIPO - Type		PESO Weight Kg	PD ² Kg f x m ²	B	I	H	H1	H2	J	K	M	Q	R	Ø
VENTILATORE Fan	MOTORE Motor													
PRM320/2R	132 SA2	115	1,2	673	237	560	320	560	337	372	336	40	59	12
PRM320/2	132 SB2	118	1,4	673	237	560	320	560	337	372	336	40	59	12
PRM320/T		98	1,4			560	320	560						

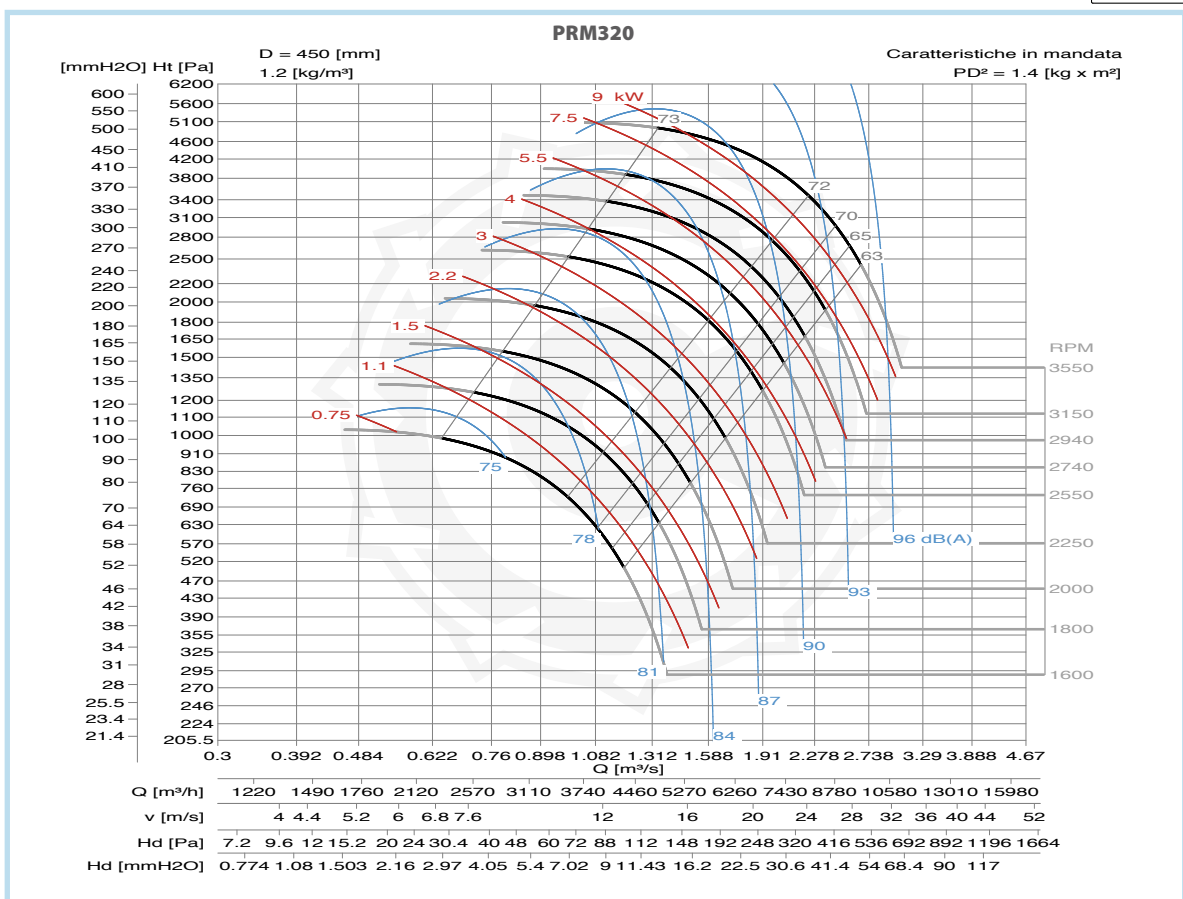
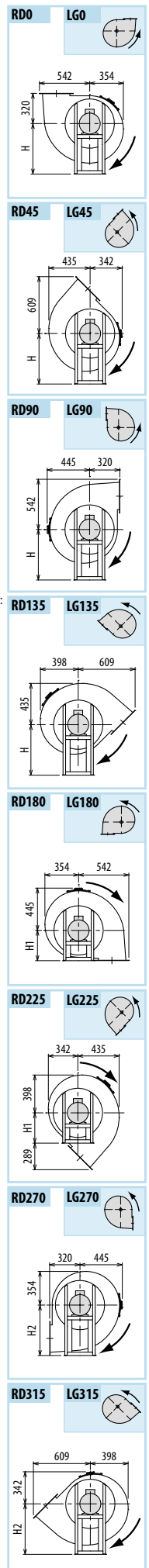
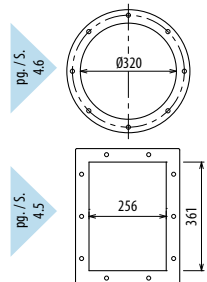

DIMENSIONI D'INGOMBRO E PESI/CURVE DI FUNZIONAMENTO

■ DIMENSIONS D'ENCOMBREMENT ET POIDS/COURBES DE FONCTIONNEMENT ■ OVERALL DIMENSIONS AND WEIGHT/WORKING CURVES
 ■ AUSMAßE UND GEWICHTE/FUNKTIONSKURVEN ■ DIMENSIONES QUE OCUPA Y PESOS/CURVAS DE FUNCIONAMIENTO

PRM360

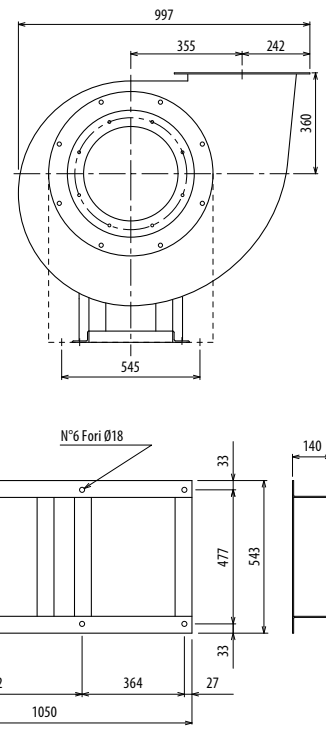
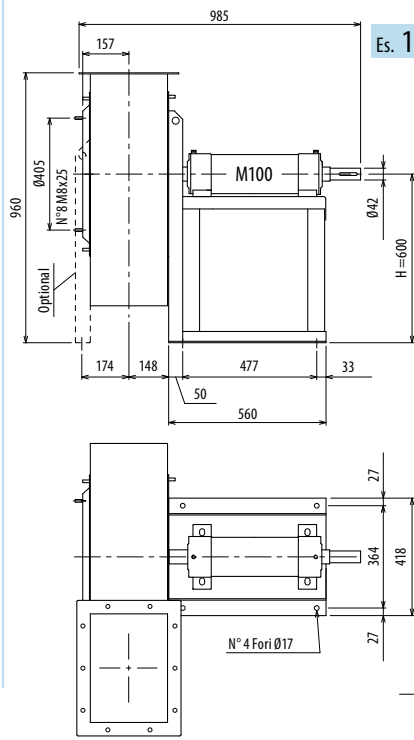
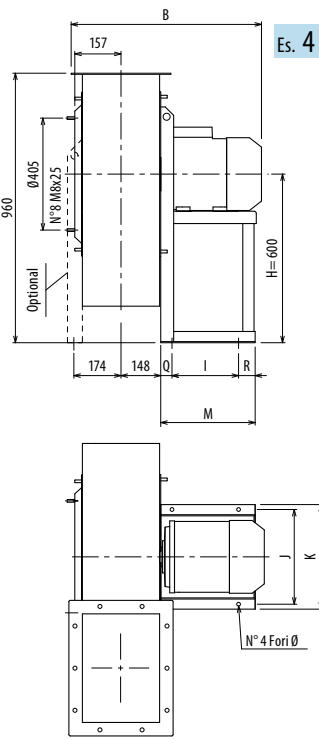

Il ventilatore è orientabile • Peso in tabella comprensivo di motore

- Le ventilateur est orientable
 - The fan is revolvable
 - Der Ventilator ist drehbar
 - El ventilador es orientable
- Le poids dans le tableau inclut le moteur The weight indicated in the table includes motor Gewichtsangabe in Tabelle inkl. Motor El peso en la tabla incluye el motor

Ulteriori informazioni e quote:
 ■ Ulérieures informations et cotes:
 ■ Further information and sizes:
 ■ Weitere Infos und Größen:
 ■ Más informaciones y medidas:

TIPO - Type		PESO Weight	PD ²											
VENTILATORE Fan	MOTORE Motor	Kg	Kgf x m ²	B	I	H	H1	H2	J	K	M	Q	R	Ø
PRM360/2R	160 M2	175	2,3	810	337	600	360	600	395	440	436	50	49	14
PRM360/2	160 M2	180	2,6	810	337	600	360	600	395	440	436	50	49	14
PRM360/4R	90 S4	100	2,1	613	133	600	360	600	234	260	246	55	58	10
PRM360/4	90 L4	106	2,2	613	133	600	360	600	234	260	246	55	58	10
PRM360/T		115	2,6			600	360	600						

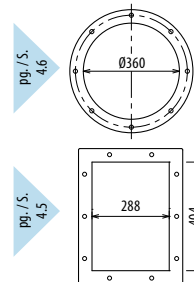

RD0 LG0

RD45 LG45

RD90 LG90

RD135 LG135

RD180 LG180

RD225 LG225

RD270 LG270

RD315 LG315

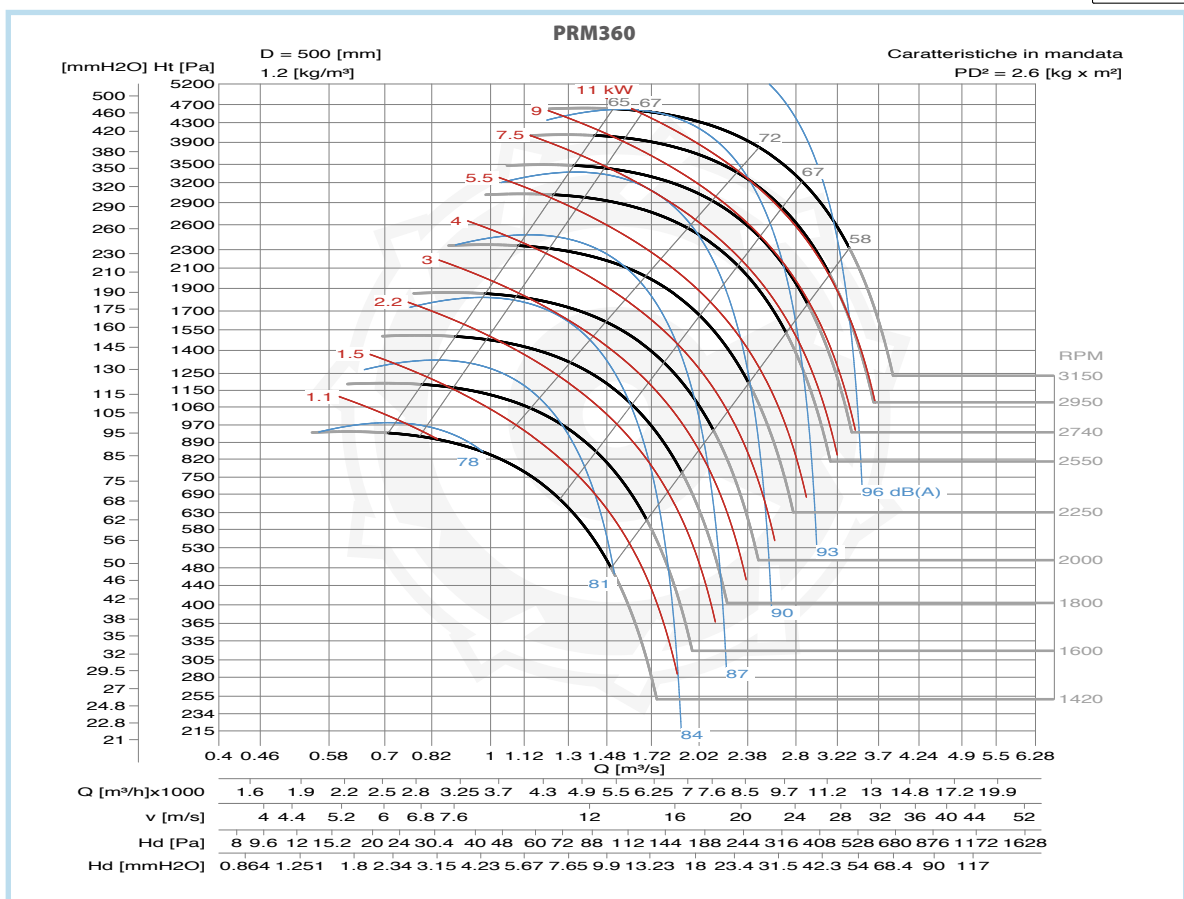

PRM

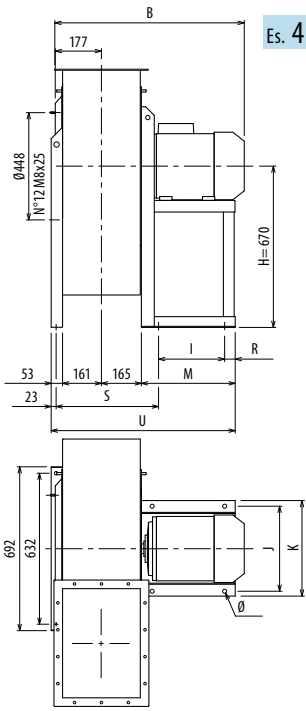

Es. 4

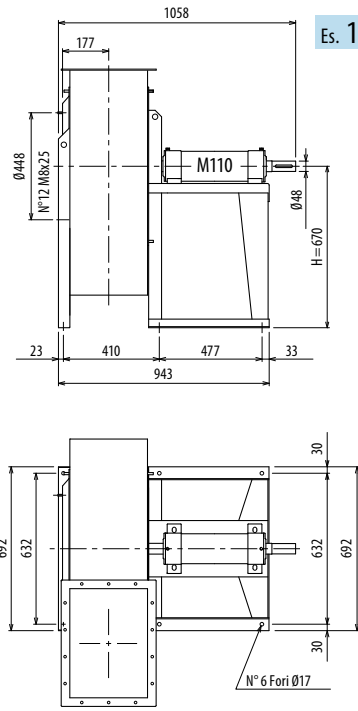

Es. 1

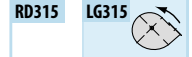
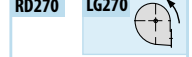
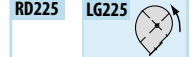
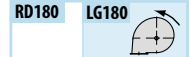
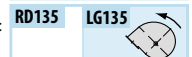
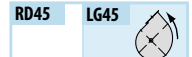
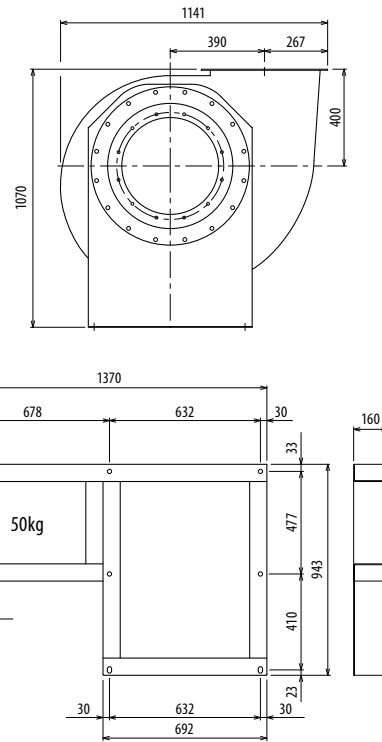

Il ventilatore è orientabile • Peso in tabella comprensivo di motore

- Le ventilateur est orientable
 - The fan is revolvable
 - Der Ventilator ist drehbar
 - El ventilador es orientable
- Le poids dans le tableau inclut le moteur The weight indicated in the table includes motor Gewichtsangabe in Tabelle inkl. Motor El peso en la tabla incluye el motor

Ulteriori informazioni e quote:
■ Ulérieures informations et cotes:
■ Further information and sizes:
■ Weitere Infos und Größen:
■ Más informaciones y medidas:

TIPO - Type		PESO Weight	PD ²												
VENTILATORE Fan	MOTORE Motor	Kg	Kgf x m ²	B	I	H	H1	H2	J	K	M	R	S	U	Ø
PRM400/2R	160 L2	220	3,4	857	337	670	400	670	395	440	436	49	406	815	14
PRM400/2	180 M2	276	3,8	938	357	670	400	670	434	488	460	33	426	839	17
PRM400/4R	100 LA4	128	3,2	691	197	670	400	670	289	324	276	49	386	655	12
PRM400/4	100 LB4	136	3,3	691	197	670	400	670	289	324	276	49	386	655	12
PRM400/T		194	3,8			670	400	670							

pg. / s. 4/6

pg. / s. 4/5

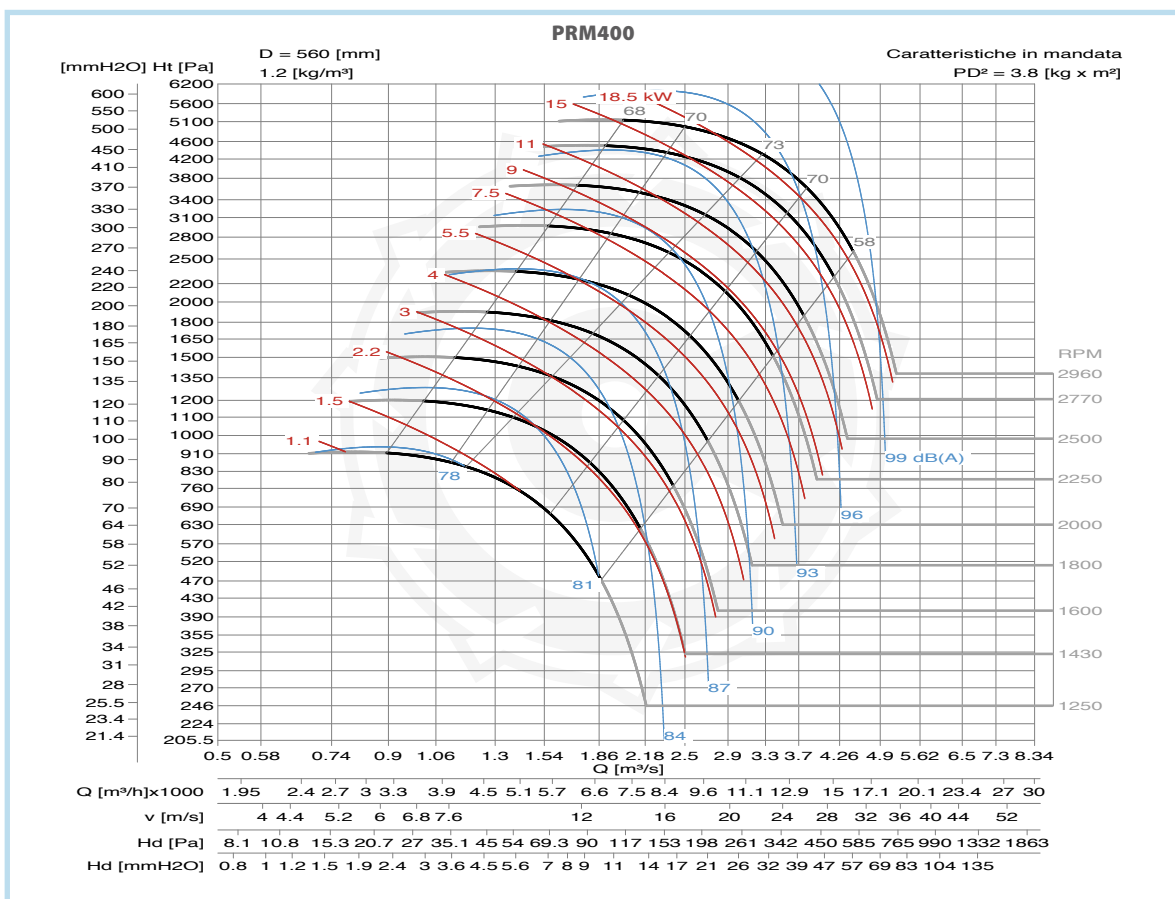
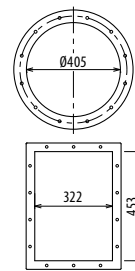

DIMENSIONI D'INGOMBRO E PESI/CURVE DI FUNZIONAMENTO

■ DIMENSIONS D'ENCOMBREMENT ET POIDS/COURBES DE FONCTIONNEMENT ■ OVERALL DIMENSIONS AND WEIGHT/WORKING CURVES
 ■ AUSMAßE UND GEWICHTE/FUNKTIONSKURVEN ■ DIMENSIONES QUE OCUPA Y PESOS/CURVAS DE FUNCIONAMIENTO

PRM450

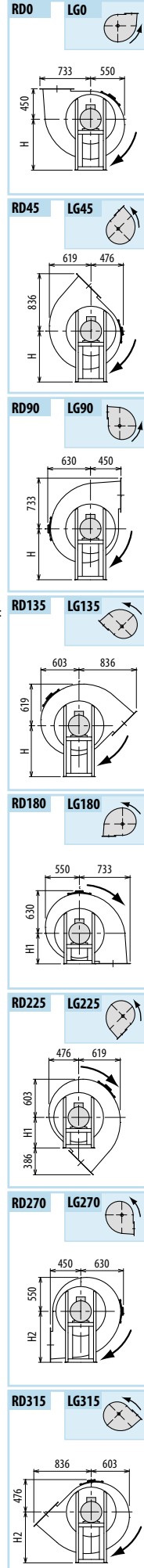
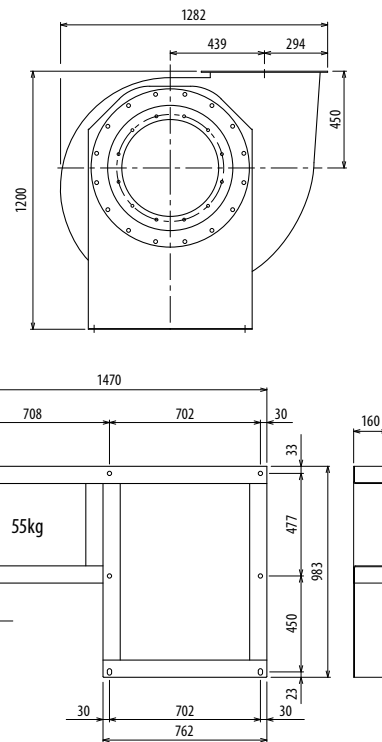
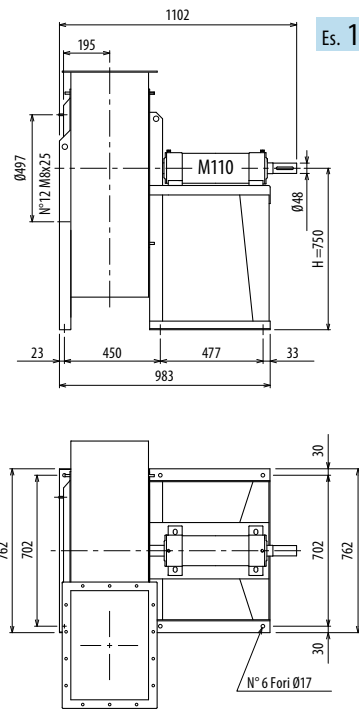
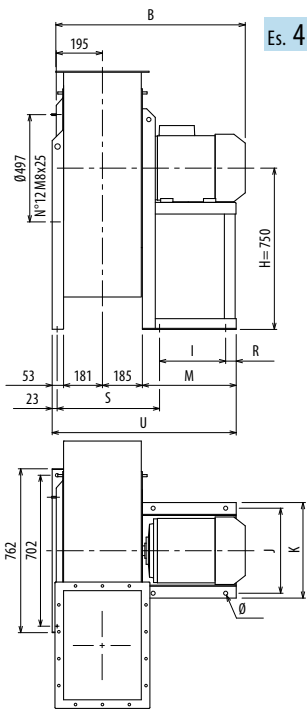

Il ventilatore è orientabile • Peso in tabella comprensivo di motore

- Le ventilatore est orientable
 - The fan is revoluble
 - Der Ventilator ist drehbar
 - El ventilador es orientable
- Le poids dans le tableau inclut le moteur The weight indicated in the table includes motor Gewichtsangabe in Tabelle inkl. Motor El peso en la tabla incluye el motor

Ulteriori informazioni e quote:
 ■ Ulérieures informations et cotes:
 ■ Further information and sizes:
 ■ Weitere Infos und Größen:
 ■ Más informaciones y medidas:

TIPO - Type		PESO Weight	PD ²	B	I	H	H1	H2	J	K	M	R	S	U	Ø
VENTILATORE Fan	MOTORE Motor	Kg	Kgf x m ²												
PRM450/4R	112 M4	190	5,6	752	197	750	450	750	289	324	276	49	425	694	12
PRM450/4	132 S4	205	6,3	792	237	750	450	750	337	372	336	59	435	754	12
PRM450/T		229	6,7			750	450	750							

pg. / s. 4.6
 pg. / s. 4.5

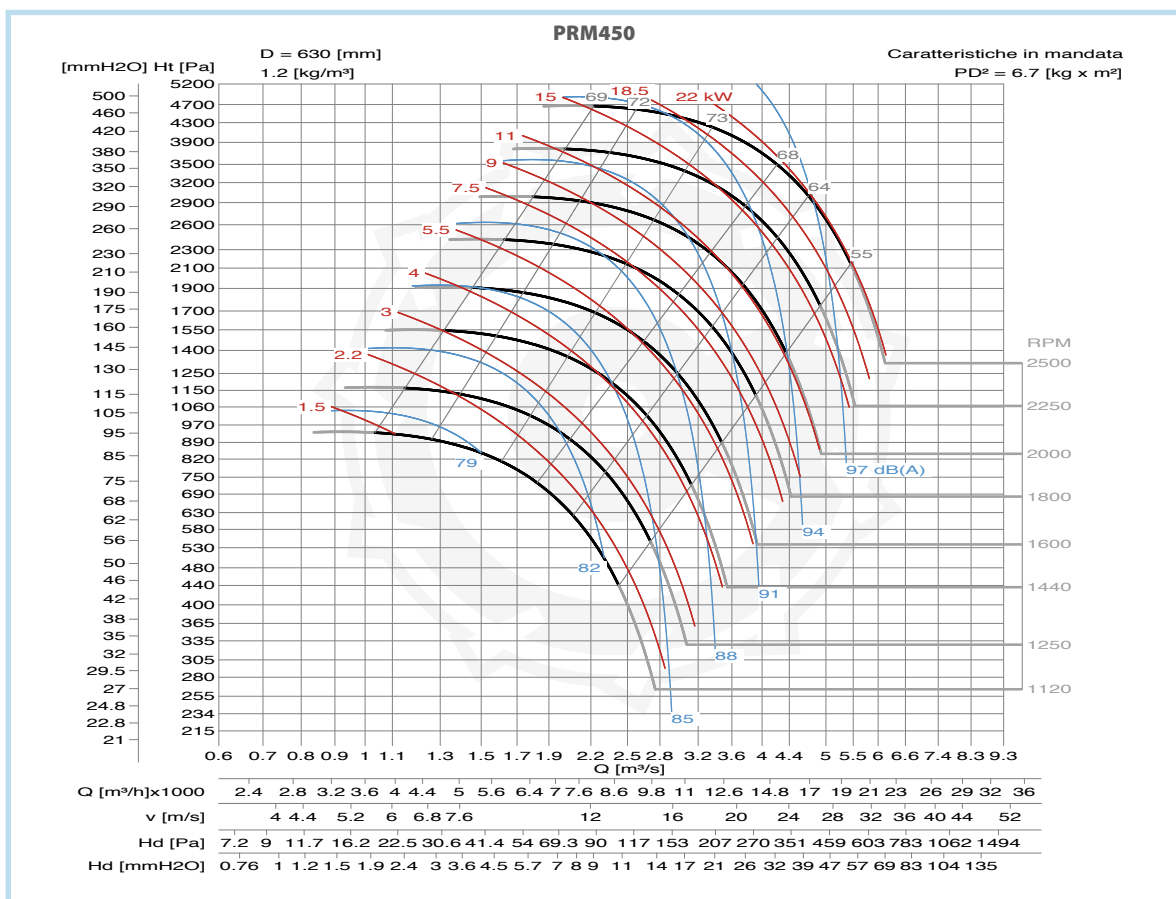
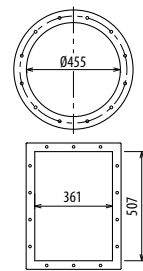

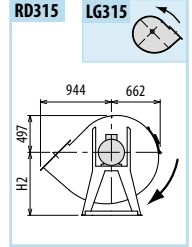
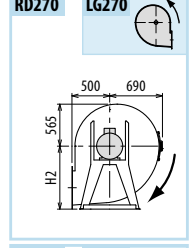
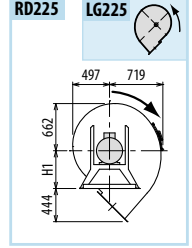
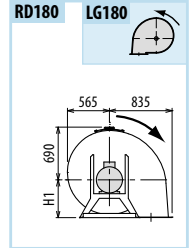
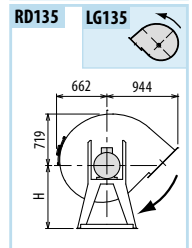
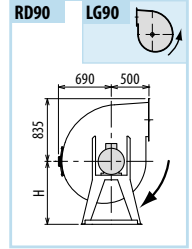
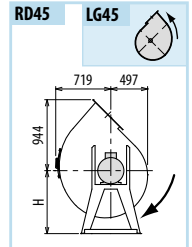
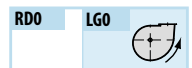
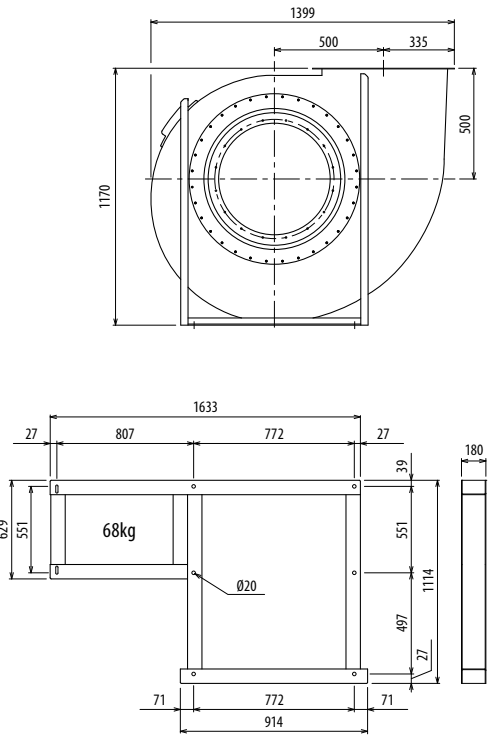
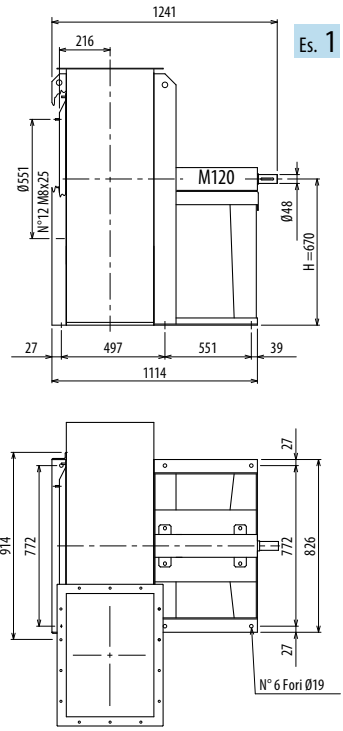
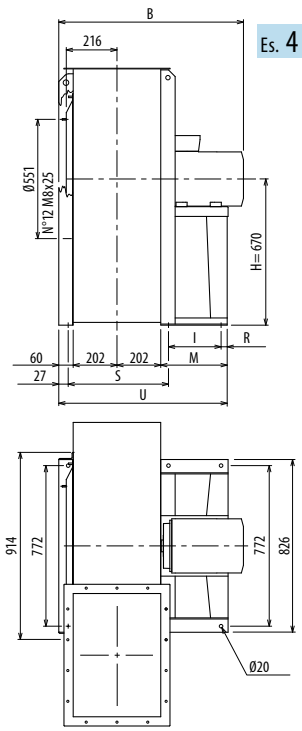

Il ventilatore non è orientabile • Peso in tabella comprensivo di motore

- Le ventilateur n'est pas orientable
- The fan is not revolvable
- Der Ventilator ist nicht drehbar
- El ventilador no es orientable
- Ulteriori informazioni e quote:
- Further information and sizes:
- Weitere Infos und Größen:
- Más informaciones y medidas:

TIPO - Type		PESO Weight Kg	PD ² Kgf x m ²	B	I	H	H1	H2	R	S	M	U
VENTILATORE Fan	MOTORE Motor											
PRM500/4R	132 M4	287	10	837	201	670	500	850	75	497	336	800
PRM500/4	160 M4	338	11	942	316	670	500	850	60	497	436	900
PRM500/T		346	12			670	500	850				

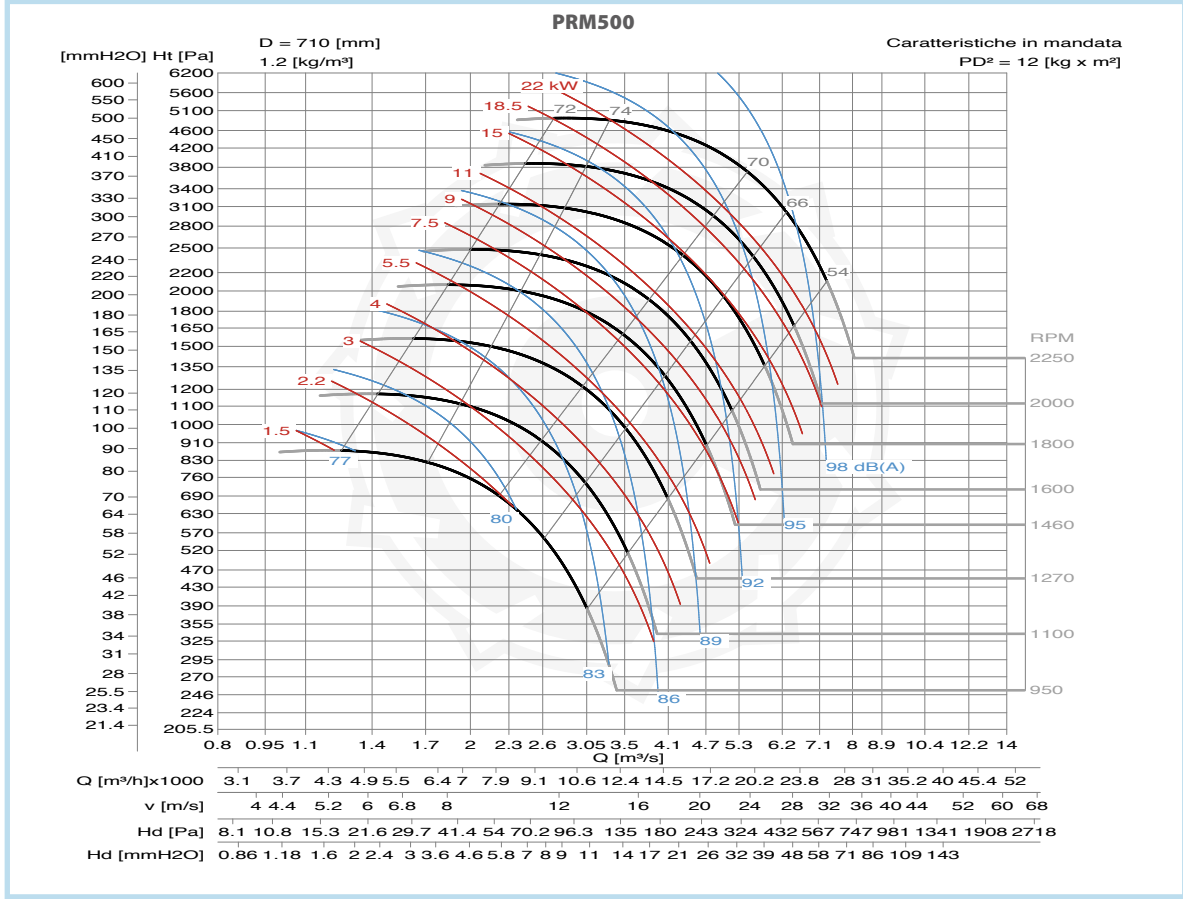
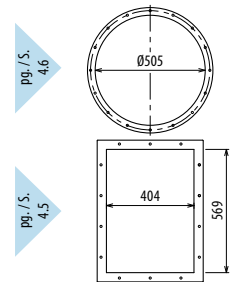

DIMENSIONI D'INGOMBRO E PESI/CURVE DI FUNZIONAMENTO

■ DIMENSIONS D'ENCOMBREMENT ET POIDS/COURBES DE FONCTIONNEMENT ■ OVERALL DIMENSIONS AND WEIGHT/WORKING CURVES
 ■ AUSMAßE UND GEWICHTE/FUNKTIONSKURVEN ■ DIMENSIONES QUE OCUPA Y PESOS/CURVAS DE FUNCIONAMIENTO

PRM560

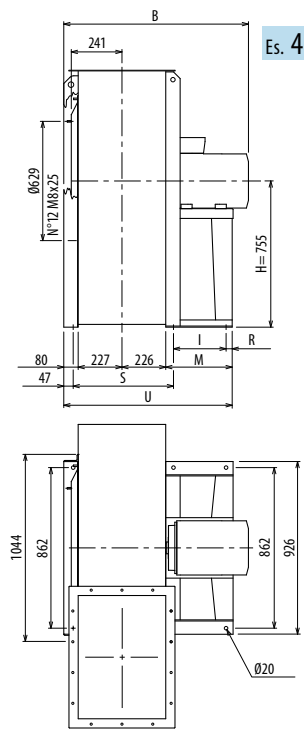

Es. 4

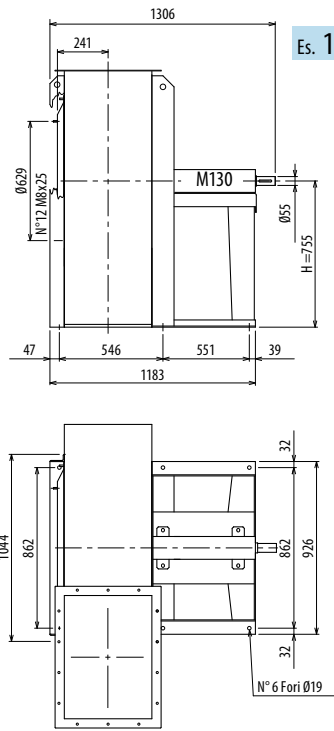

Es. 1

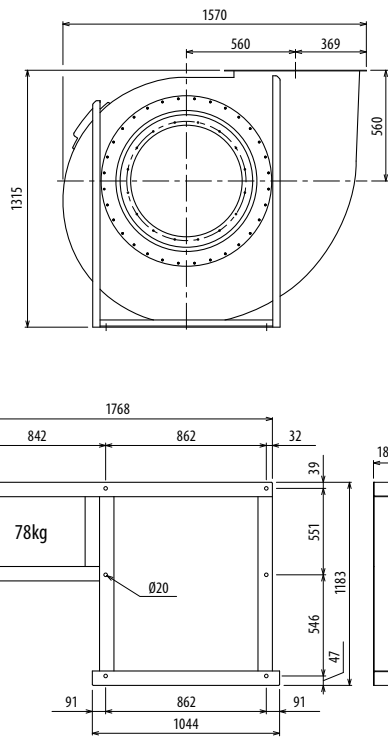

Il ventilatore non è orientabile • Peso in tabella comprensivo di motore

■ Le ventilateur n'est pas orientable
Le poids dans le tableau inclut le moteur

■ The fan is not revolvable
The weight indicated in the table includes motor

■ Der Ventilator ist nicht drehbar
Gewichtangabe in Tabelle inkl. Motor

■ El ventilador no es orientable
El peso en la tabla incluye el motor

Ulteriori informazioni e quote:
 ■ Ulérieures informations et cotes:
 ■ Further information and sizes:
 ■ Weitere Infos und Größen:
 ■ Más informaciones y medidas:

TIPO - Type		PESO Weight	PD ²	B	I	H	H1	H2	R	S	M	U
VENTILATORE Fan	MOTORE Motor	Kg	Kgf x m ²									
PRM560/4R	160 L4	504	17	1011	315	755	560	950	60	546	436	968
PRM560/4	180 M4	512	19	1092	361	755	560	950	39	546	460	993
PRM560/6R	132 M6	391	16	906	201	755	560	950	75	546	336	869
PRM560/6	132 M6	395	18	906	201	755	560	950	75	546	336	869
PRM560/T		421	19			755	560	950				

pg. / s. 4/6

pg. / s. 4/5

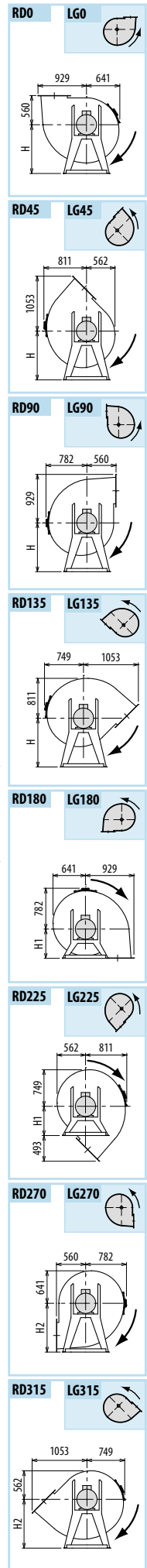
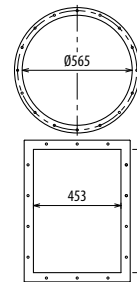

PRM

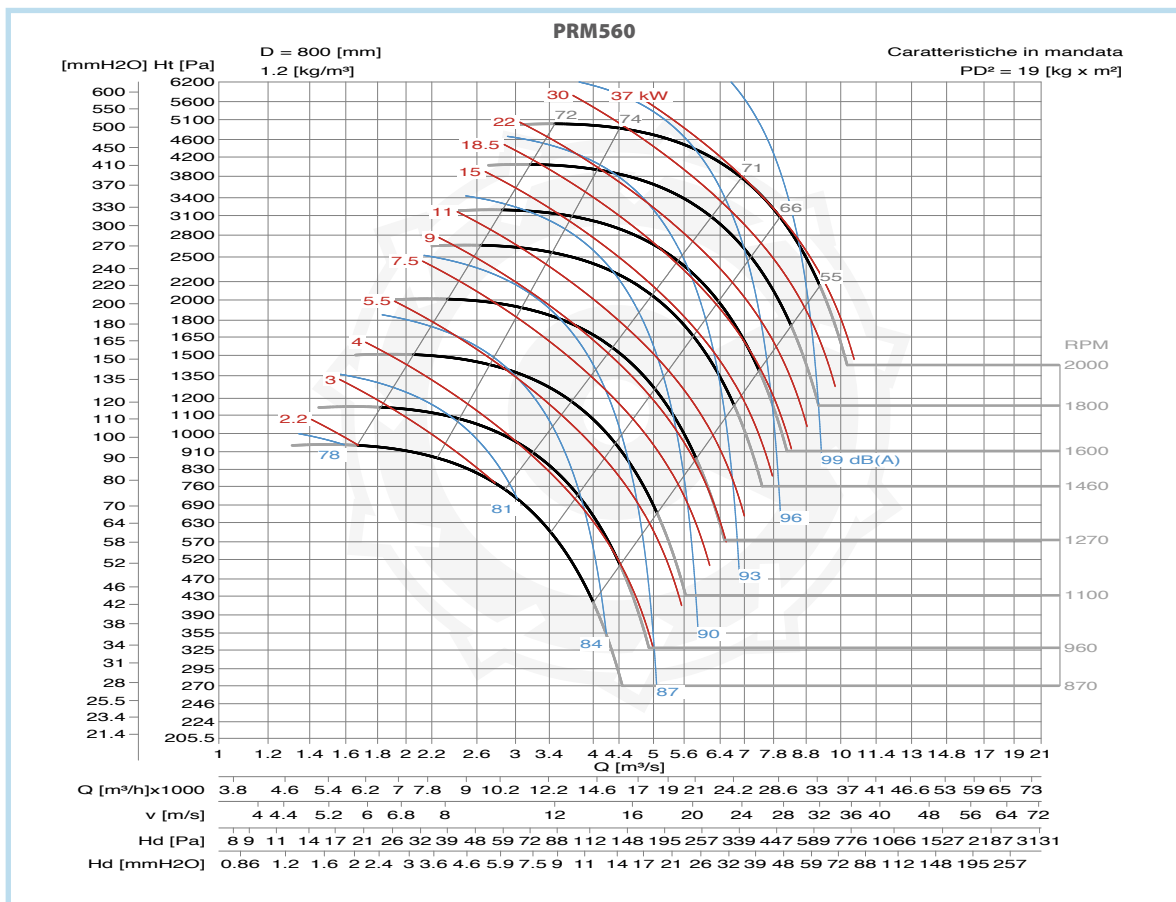

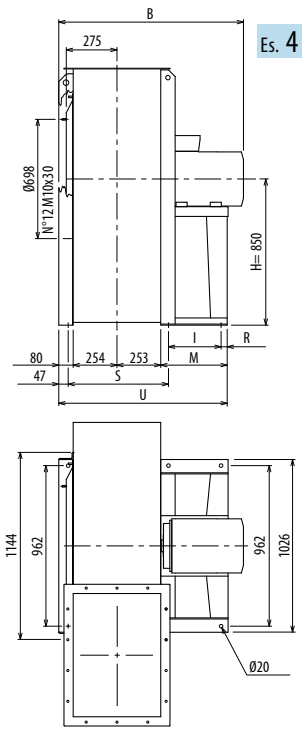

Es. 4

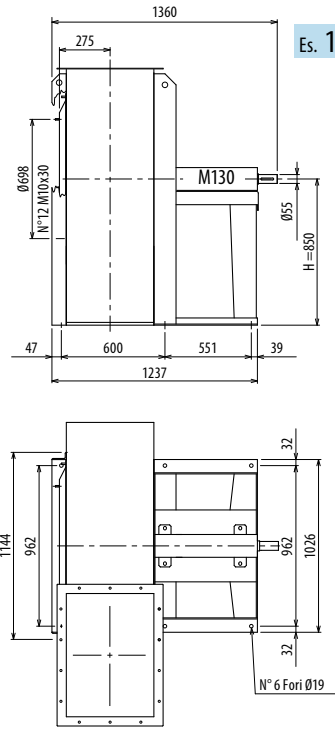

Es. 1

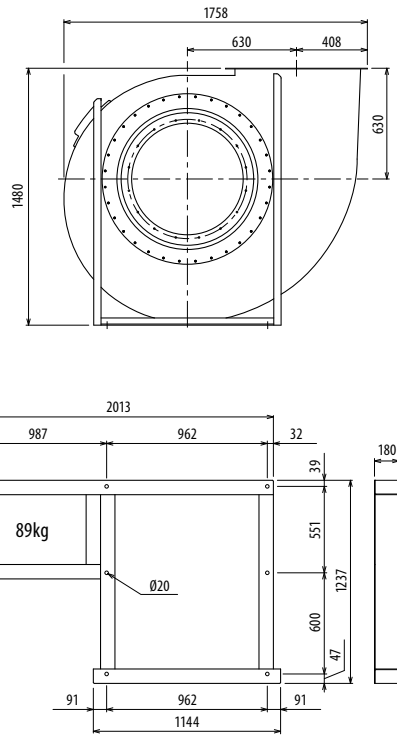

Il ventilatore non è orientabile • Peso in tabella comprensivo di motore

■ Le ventilateur n'est pas orientable
Le poids dans le tableau inclut le moteur

■ The fan is not revolvable
The weight indicated in the table includes motor

■ Der Ventilator ist nicht drehbar
Gewichtsangabe in Tabelle inkl. Motor

■ El ventilador no es orientable
El peso en la tabla incluye el motor

Ulteriori informazioni e quote:
■ Ulérieures informations et cotes:
■ Further information and sizes:
■ Weitere Infos und Größen:
■ Más informaciones y medidas:

TIPO - Type		PESO Weight Kg	PD ² Kgf x m ²	B	I	H	H1	H2	R	S	M	U
VENTILATORE Fan	MOTORE Motor											
PRM630/4R	200 L4	684	30	1254	401	850	630	1060	39	600	500	1087
PRM630/4	225 S4	767	34	1236	441	850	630	1060	39	600	540	1127
PRM630/6R	160 M6	511	29	1065	316	850	630	1060	60	600	436	1023
PRM630/6	160 L6	531	33	1065	316	850	630	1060	60	600	436	1023
PRM630/T		517	34			850	630	1060				

pg. / s. 4.6

pg. / s. 4.5

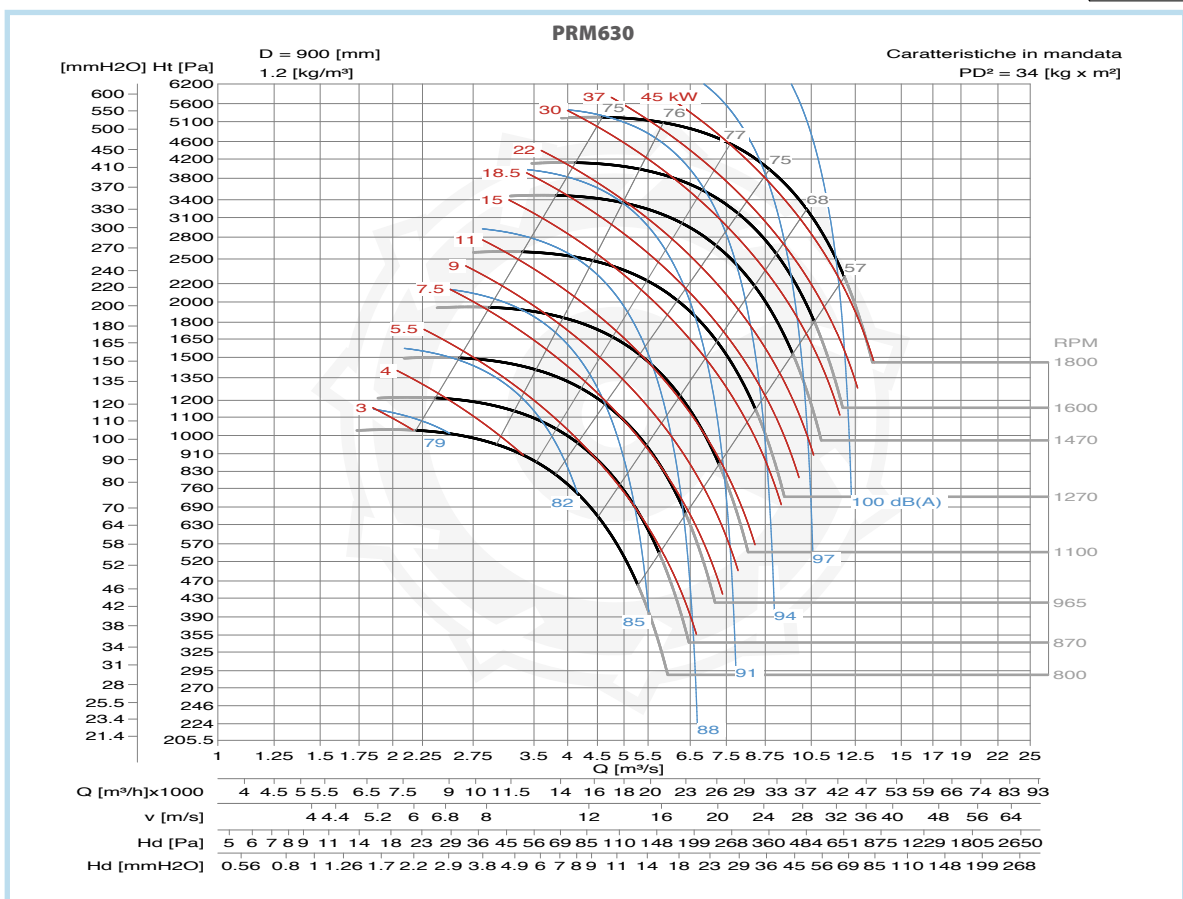
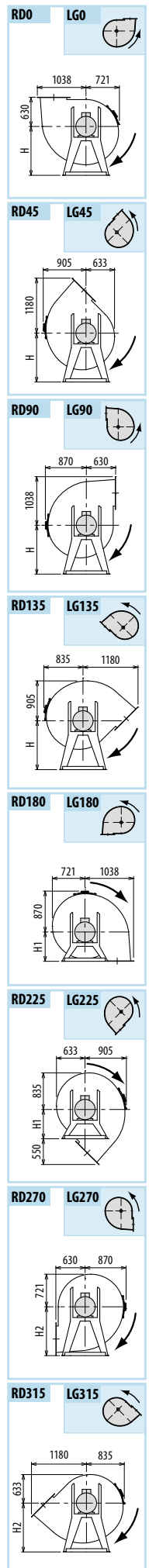
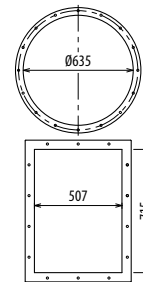

DIMENSIONI D'INGOMBRO E PESI/CURVE DI FUNZIONAMENTO

■ DIMENSIONS D'ENCOMBREMMENT ET POIDS/COURBES DE FONCTIONNEMENT ■ OVERALL DIMENSIONS AND WEIGHT/WORKING CURVES
 ■ AUSMAßE UND GEWICHTE/FUNKTIONSKURVEN ■ DIMENSIONES QUE OCUPA Y PESOS/CURVAS DE FUNCIONAMIENTO

PRM700

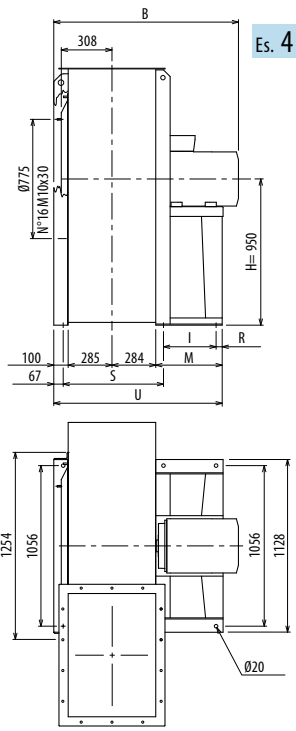

Es. 4

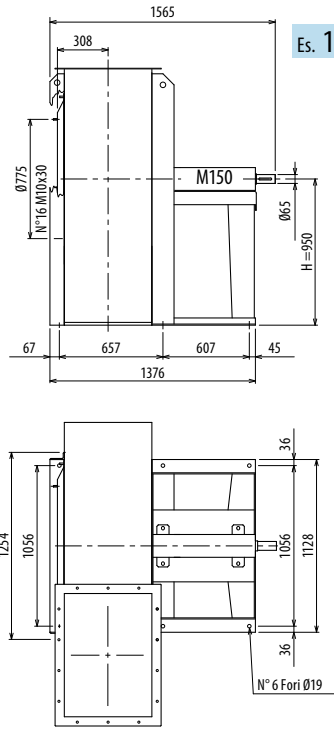

Es. 1

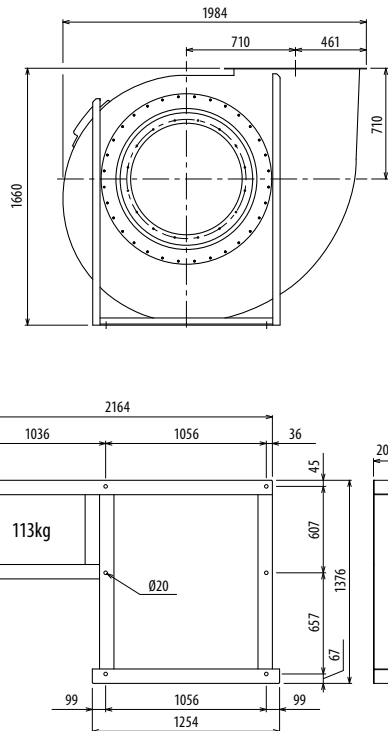

Il ventilatore non è orientabile • Peso in tabella comprensivo di motore

- Le ventilateur n'est pas orientable
 - The fan is not revolvable
 - Der Ventilator ist nicht drehbar
 - El ventilador no es orientable
- Le poids dans le tableau inclut le moteur The weight indicated in the table includes motor Gewichtsgabe in Tabelle inkl. Motor El peso en la tabla incluye el motor

Ulteriori informazioni e quote:
 ■ Ulérieures informations et cotes:
 ■ Further information and sizes:
 ■ Weitere Infos und Größen:
 ■ Más informaciones y medidas:

TIPO - Type		PESO Weight	PD ²	B	I	H	H1	H2	R	S	M	U
VENTILATORE Fan	MOTORE Motor	Kg	Kgf x m ²									
PRM700/4R	225 M4	963	48	1378	440	950	710	1180	45	657	540	1209
PRM700/4	250 M4	1081	53	1486	500	950	710	1180	45	657	600	1269
PRM700/6R	180 L6	743	47	1279	360	950	710	1180	45	657	460	1129
PRM700/6	200 L6	850	52	1336	400	950	710	1180	45	657	500	1169
PRM700/T		746	53			950	710	1180				

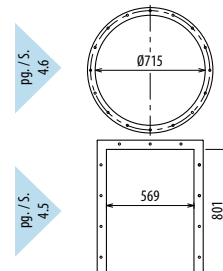

RD0 LG0

RD45 LG45

RD90 LG90

RD135 LG135

RD180 LG180

RD225 LG225

RD270 LG270

RD315 LG315

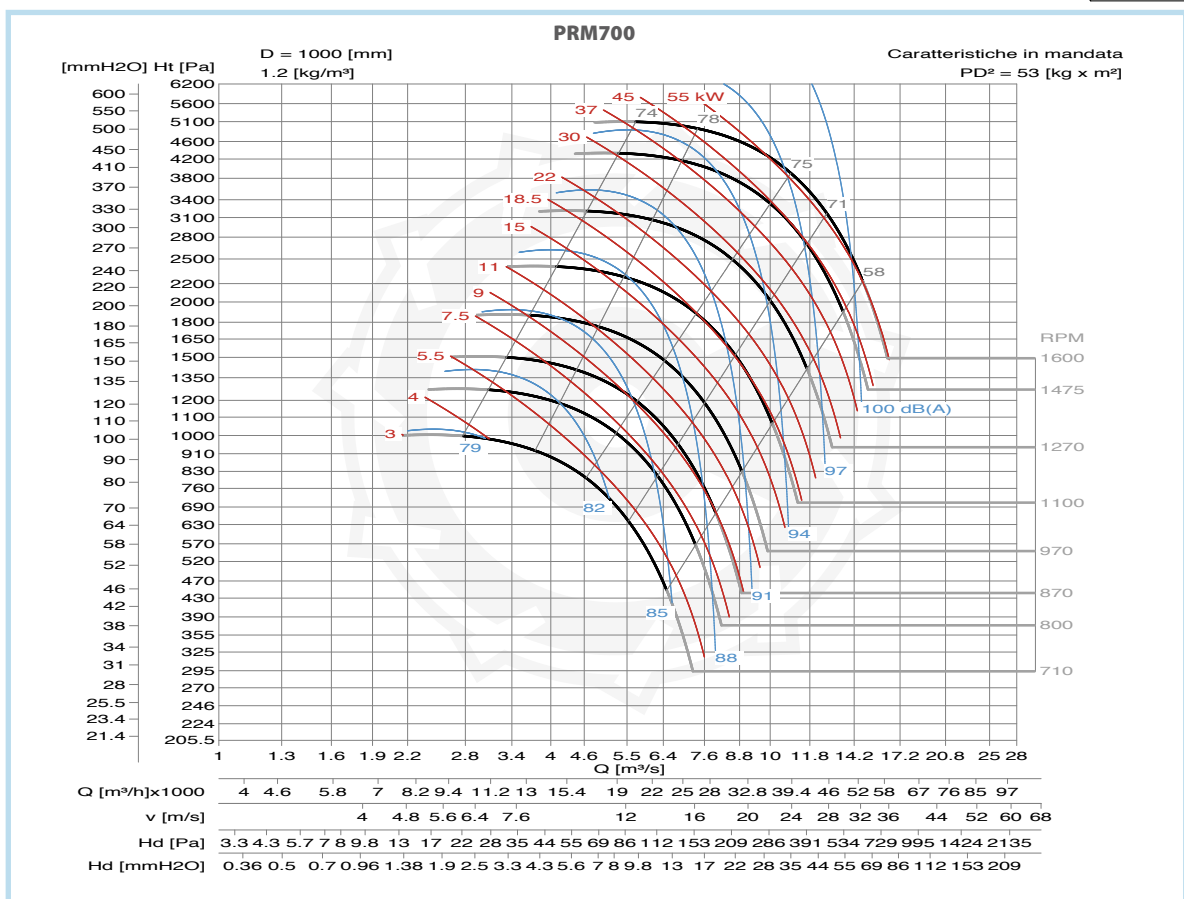

PRM

PRM

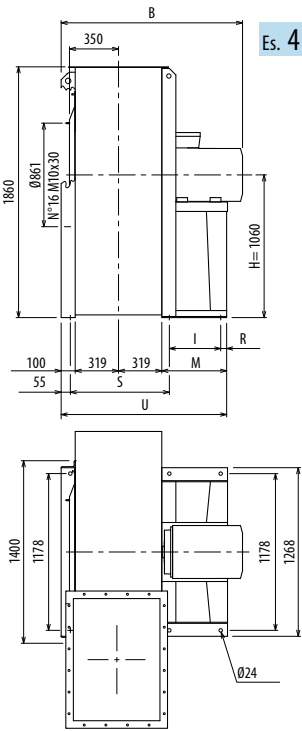

Es. 4

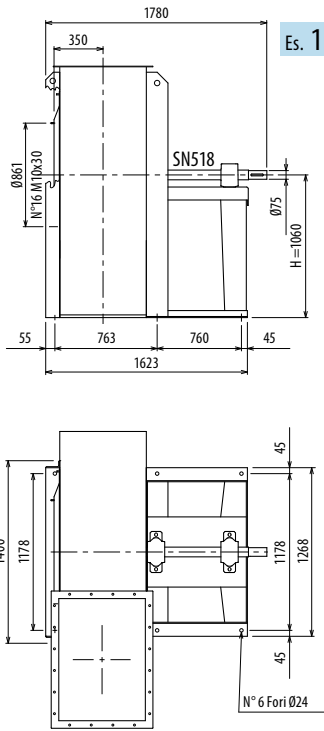

Es. 1

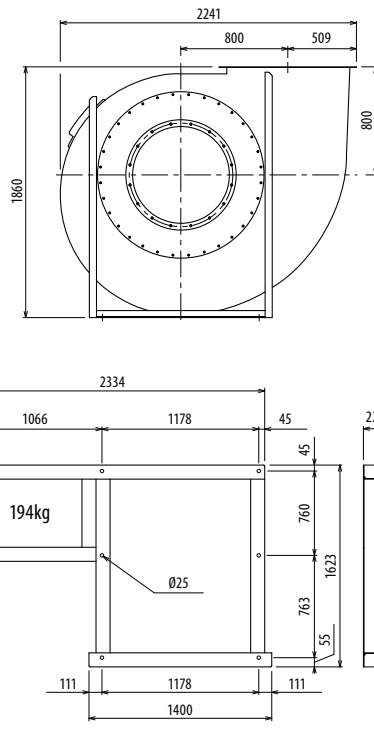

Il ventilatore non è orientabile • Peso in tabella comprensivo di motore

■ Le ventilateur n'est pas orientable
Le poids dans le tableau inclut le moteur

■ The fan is not revolvable
The weight indicated in the table includes motor

■ Der Ventilator ist nicht drehbar
Gewichtangabe in Tabelle inkl. Motor

■ El ventilador no es orientable
El peso en la tabla incluye el motor

Ulteriori informazioni e quote:
 ■ Ulérieures informations et cotes:
 ■ Further information and sizes:
 ■ Weitere Infos und Größen:
 ■ Más informaciones y medidas:

TIPO • Type		PESO Weight Kg	PD ² Kg x m ²	B	I	H	H1	H2	R	S	M	U
VENTILATORE Fan	MOTORE Motor											
PRM800/4R	280 S4	1445	110	1558	565	1060	800	1320	45	763	690	1428
PRM800/4	280 M4	1486	120	1558	565	1060	800	1320	45	763	690	1428
PRM800/6R	200 L6	955	105	1405	375	1060	800	1320	45	763	500	1238
PRM800/6	225 M6	1156	115	1447	415	1060	800	1320	45	763	540	1278
PRM800/T		1040	120			1060	800	1320				

pg. / s. 4.6

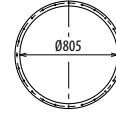

pg. / s. 4.5

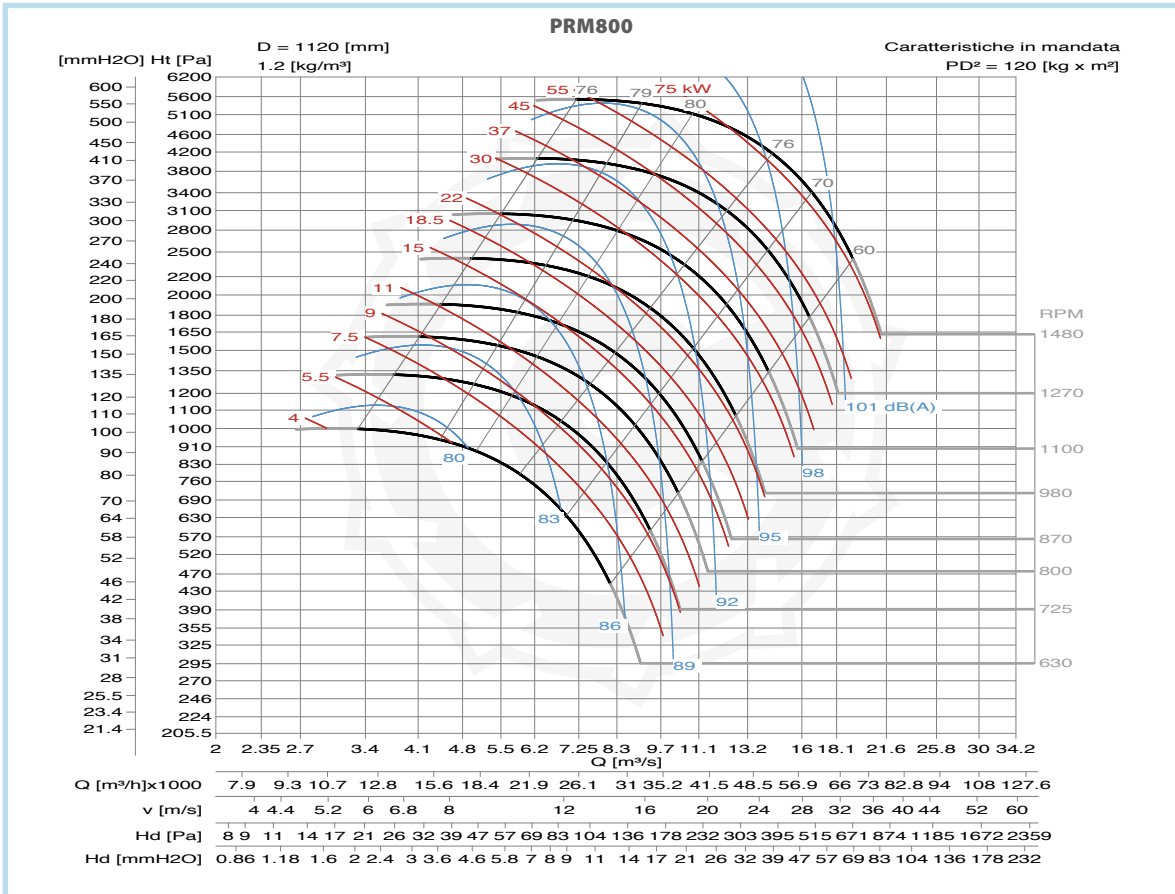
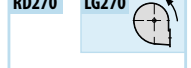
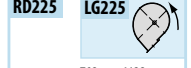
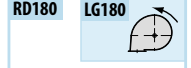
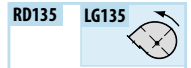
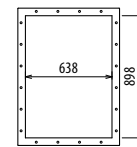

DIMENSIONI D'INGOMBRO E PESI/CURVE DI FUNZIONAMENTO

■ DIMENSIONS D'ENCOMBREMENT ET POIDS/COURBES DE FONCTIONNEMENT ■ OVERALL DIMENSIONS AND WEIGHT/WORKING CURVES
 ■ AUSMAßE UND GEWICHTE/FUNKTIONSKURVEN ■ DIMENSIONES QUE OCUPA Y PESOS/CURVAS DE FUNCIONAMIENTO

PRM900

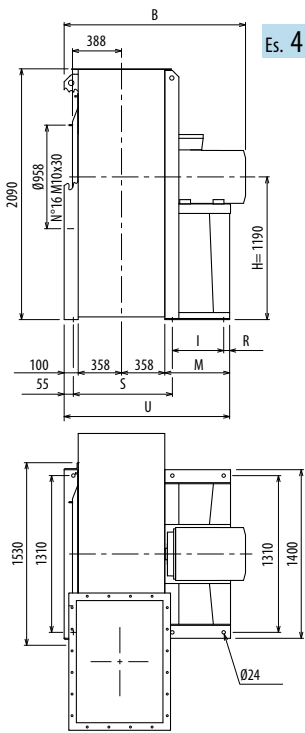

Es. 4

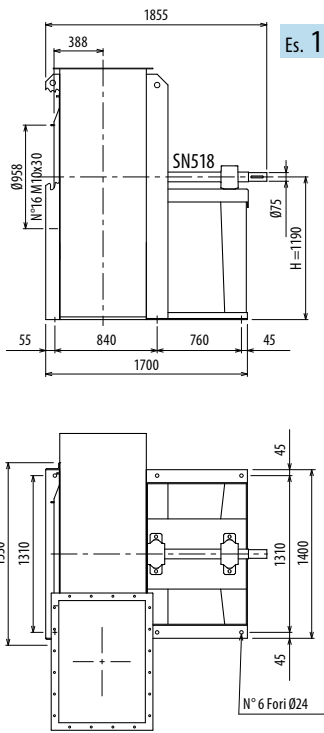

Es. 1

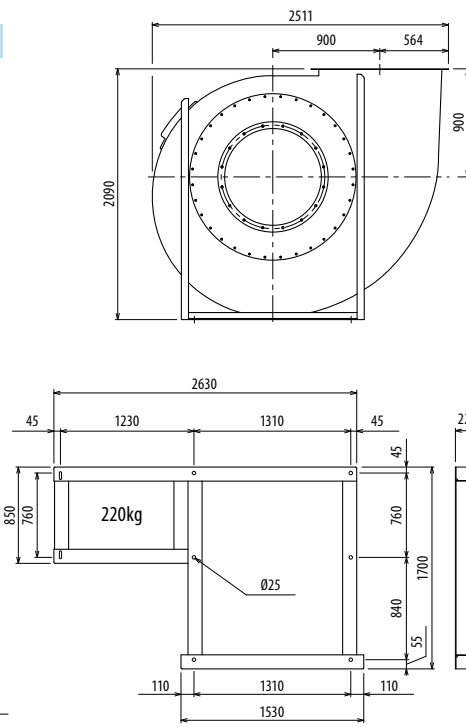

Il ventilatore non è orientabile • Peso in tabella comprensivo di motore

■ Le ventilateur n'est pas orientable ■ The fan is not revolvable ■ Der Ventilator ist nicht drehbar ■ El ventilador no es orientable ■ El peso en la tabla incluye el motor
 Le poids dans le tableau inclut le moteur The weight indicated in the table includes motor Gewichtsangabe in Tabelle inkl. Motor

Ulteriori informazioni e quote:
 ■ Ulérieures informations et cotes:
 ■ Further information and sizes:
 ■ Weitere Infos und Größen:
 ■ Más informaciones y medidas:

TIPO • Type		PESO Weight	PD ²											
VENTILATORE Fan	MOTORE Motor	Kg	Kgf x m ²	B	I	H	H1	H2	R	S	M	U		
PRM900/6R	250 M6	1430	180	1632	475	1190	900	1500	45	840	600	1415		
PRM900/6	280 S6	1915	190	1635	565	1190	900	1500	45	840	690	1505		
PRM900/T		1195	190			1190	900	1500						

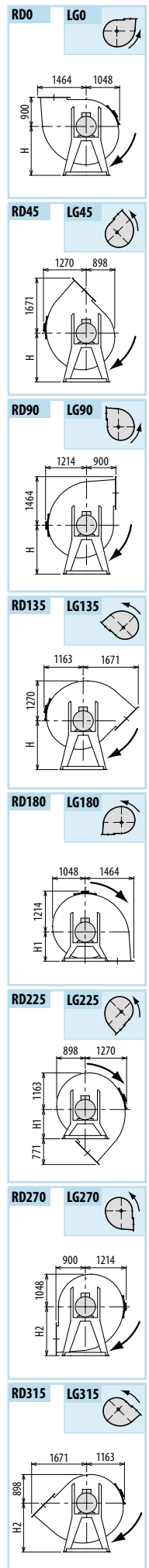
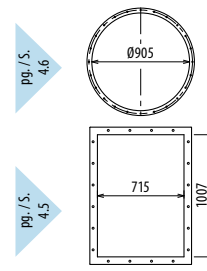

PRM

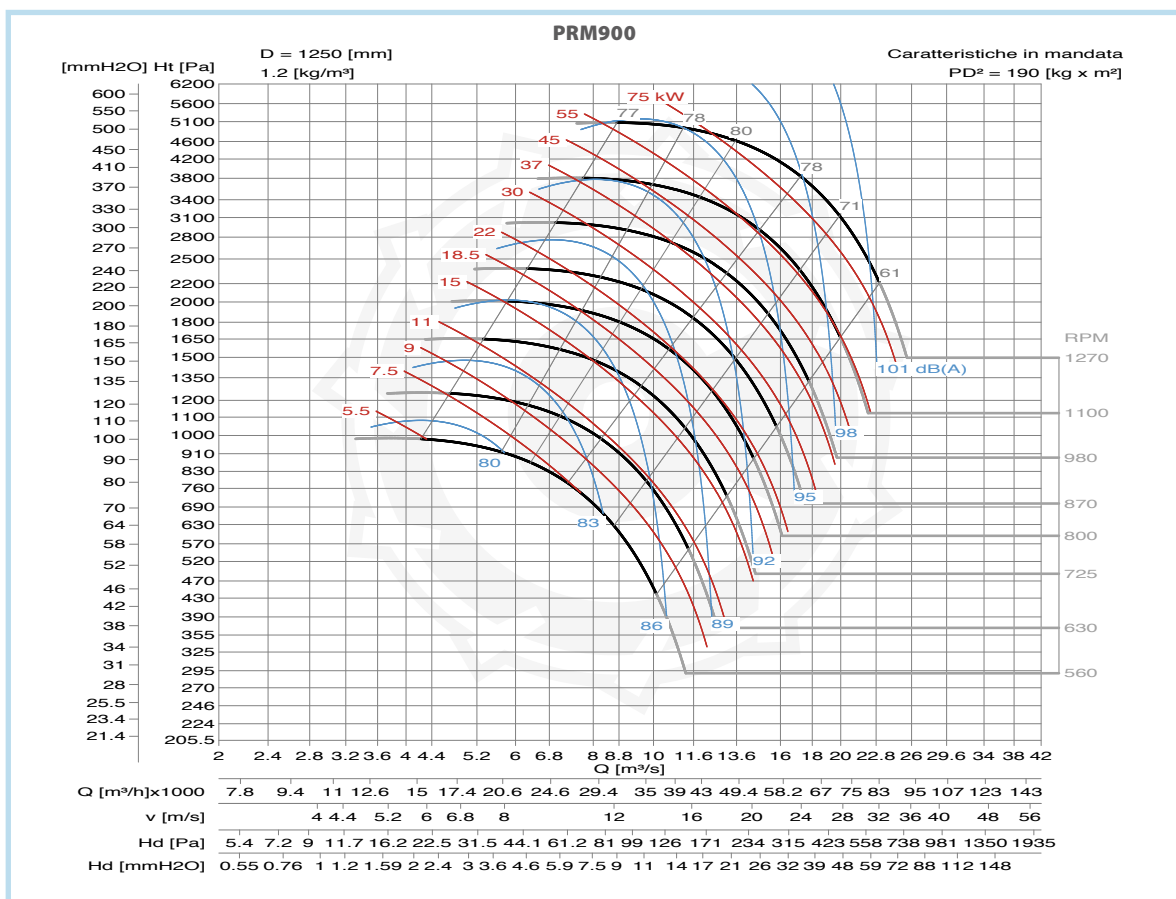

PRM

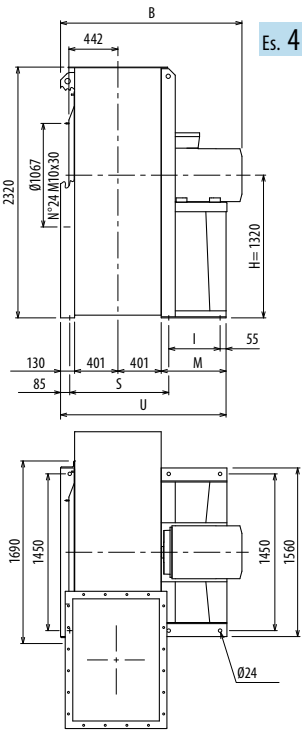

Es. 4

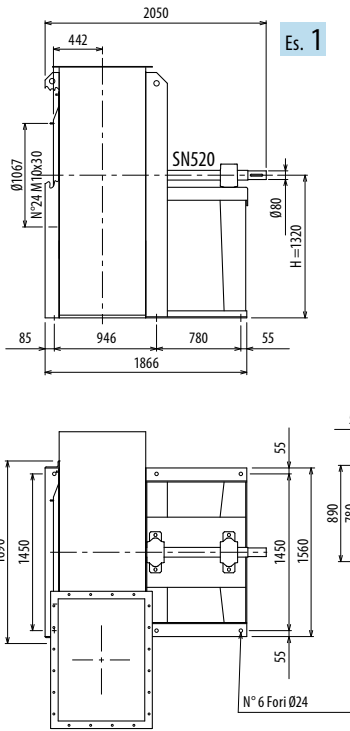

Es. 1

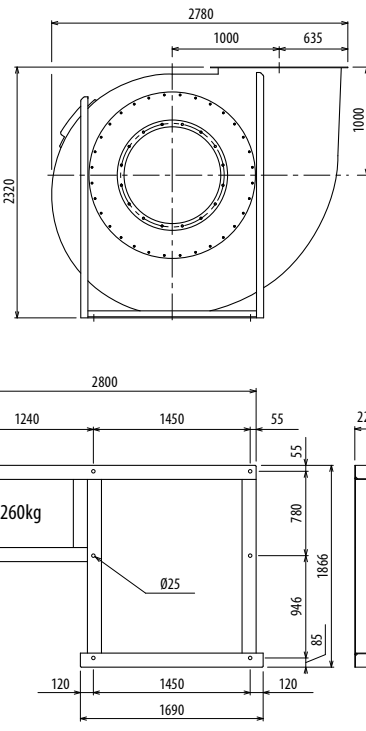

Il ventilatore non è orientabile • Peso in tabella comprensivo di motore

- Le ventilateur n'est pas orientable
- The fan is not revolvable
- Der Ventilator ist nicht drehbar
- El ventilador no es orientable
- Le poids dans le tableau inclut le moteur
- The weight indicated in the table includes motor
- Das Gewicht im Tafel schließt den Motor ein
- El peso en la tabla incluye el motor

Ulteriori informazioni e quote:

- Ulérieures informations et cotes:
- Further information and sizes:
- Weitere Infos und Größen:
- Más informaciones y medidas:

TIPO - Type		PESO Weight Kg	PD ² Kgf x m ²	B	I	H	H1	H2	H3	H4	M	S	U
VENTILATORE Fan	MOTORE Motor												
PRM1000/6R	280 M6	1850	300	1751	535	1320	1000	1700	1320	1700	690	946	1621
PRM1000/6	315 S6	2366	315	1963	645	1320	1000	1700	1320	1700	800	946	1731
PRM1000/T		1696	315			1320	1000	1700	1120	1500			

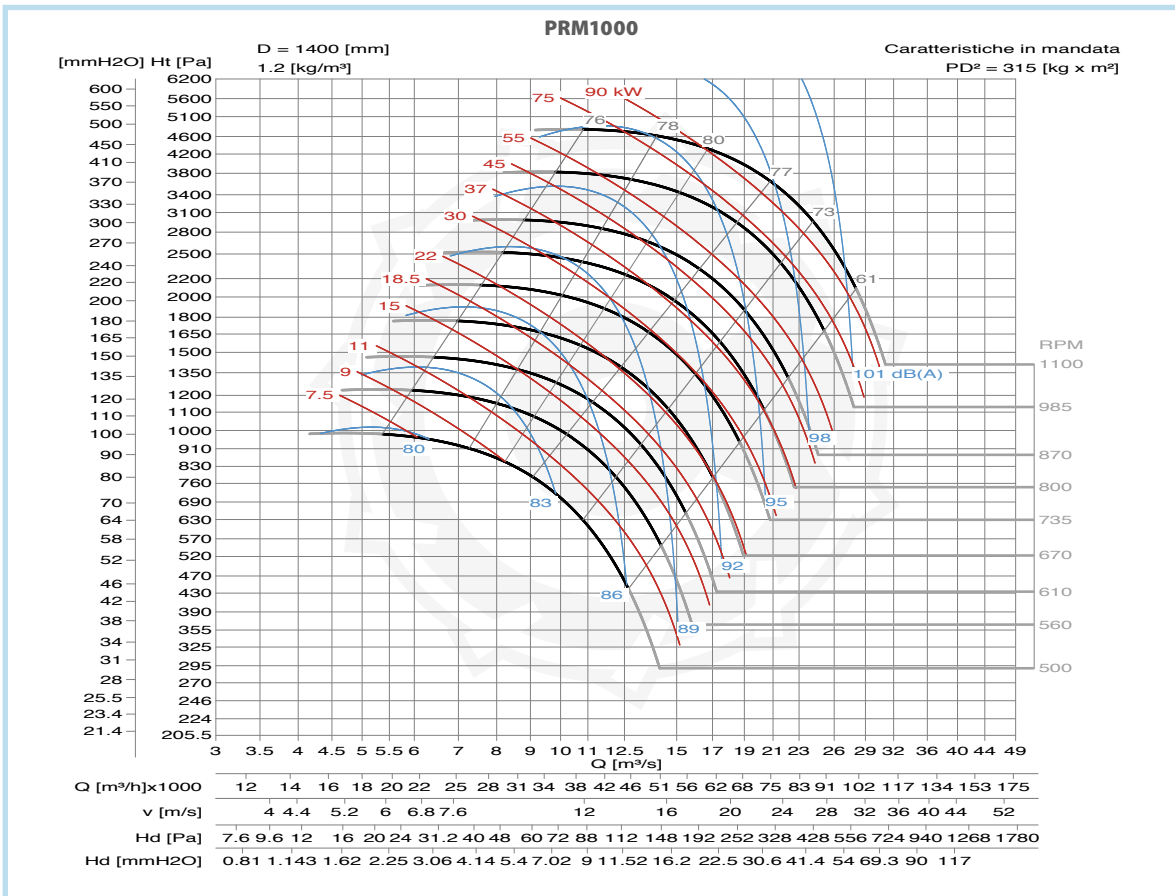
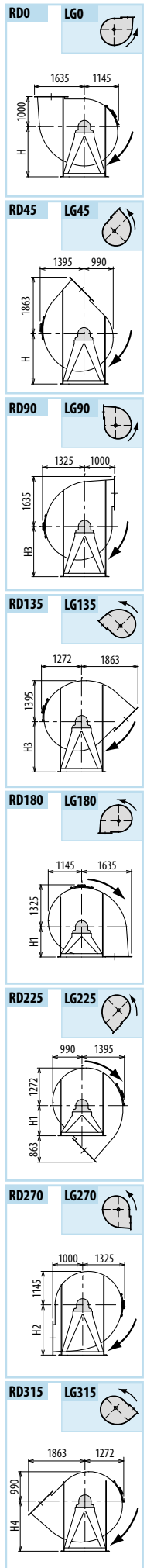
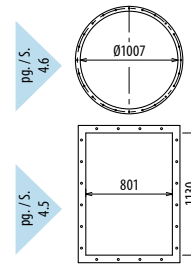

DIMENSIONI D'INGOMBRO E PESI/CURVE DI FUNZIONAMENTO

■ DIMENSIONS D'ENCOMBREMENT ET POIDS/COURBES DE FONCTIONNEMENT ■ OVERALL DIMENSIONS AND WEIGHT/WORKING CURVES
 ■ AUSMAßE UND GEWICHTE/FUNKTIONSKURVEN ■ DIMENSIONES QUE OCUPA Y PESOS/CURVAS DE FUNCIONAMIENTO

PRM1100

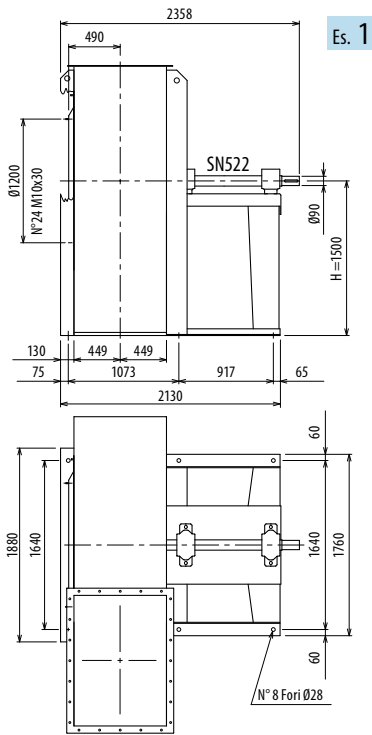

Es. 1

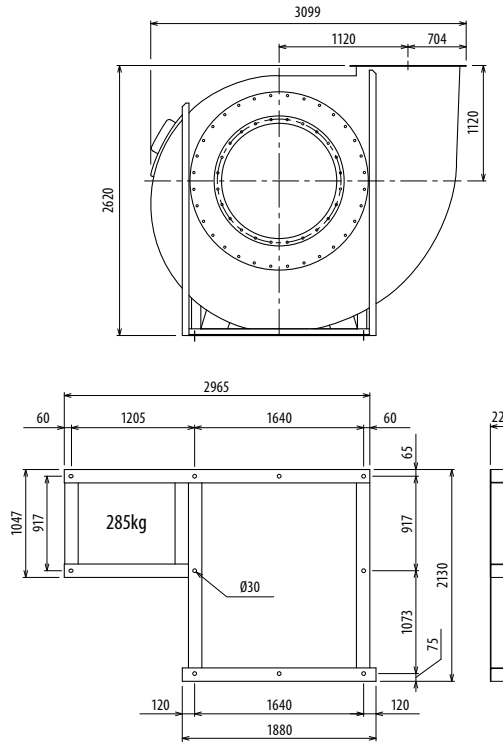

Il ventilatore non è orientabile

■ Le ventilateur n'est pas orientable

■ The fan is not revolvable

■ Der Ventilator ist nicht drehbar

■ El ventilador no es orientable

Ulteriori informazioni e quote:

■ Ulérieures informations et cotes:

■ Further information and sizes:

■ Weitere Infos und Größen:

■ Más informaciones y medidas:

TIPO - Type		PESO Weight Kg	PD² Kgf x m²	B	I	H	H1	H2	H3	H4	M
VENTILATORE Fan	MOTORE Motor										
PRM1100/T		2100	530	1500	1120	1900	1250	1600			

Pg. / S.
4,6

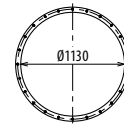

Pg. / S.
4,5

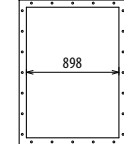

RD0 LG0

RD45 LG45

RD90 LG90

RD135 LG135

RD180 LG180

RD225 LG225

RD270 LG270

RD315 LG315

PRM

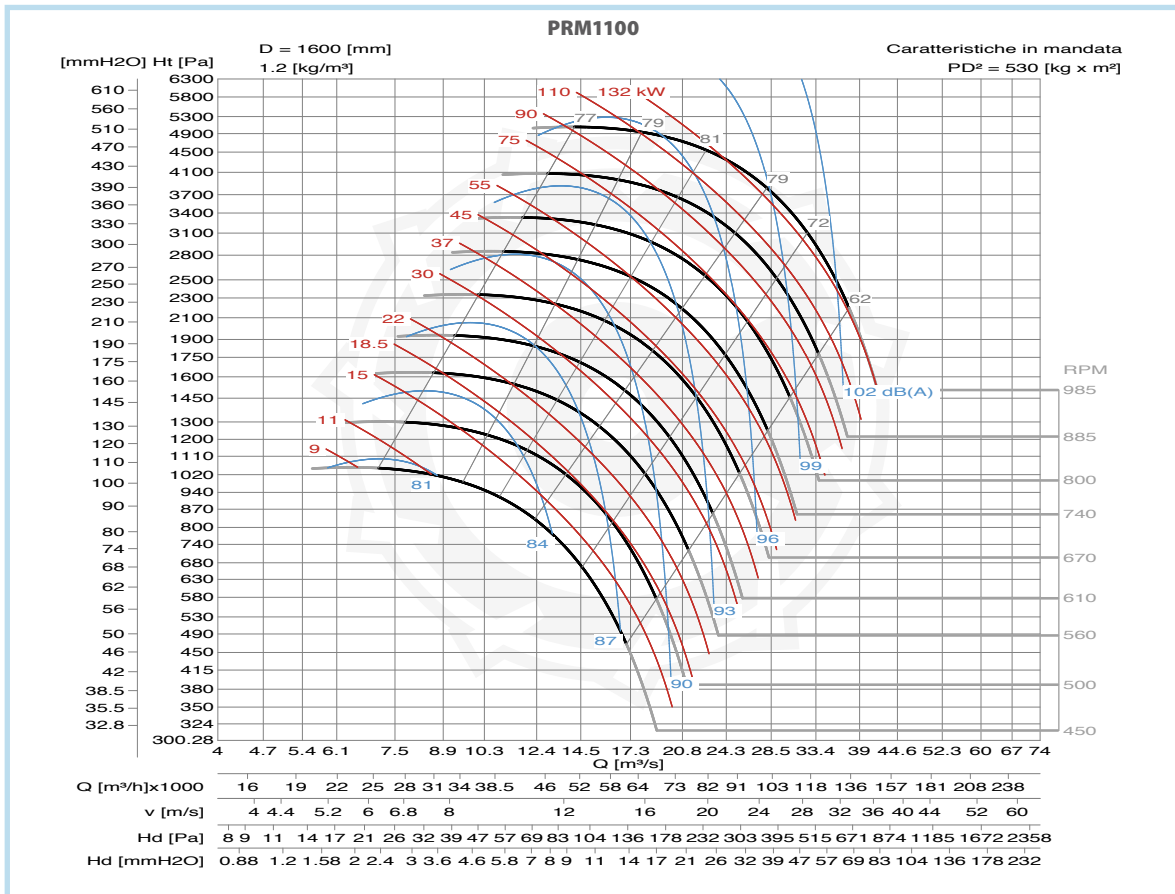

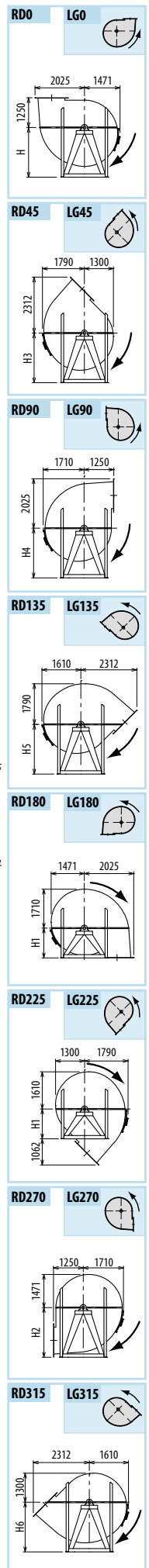
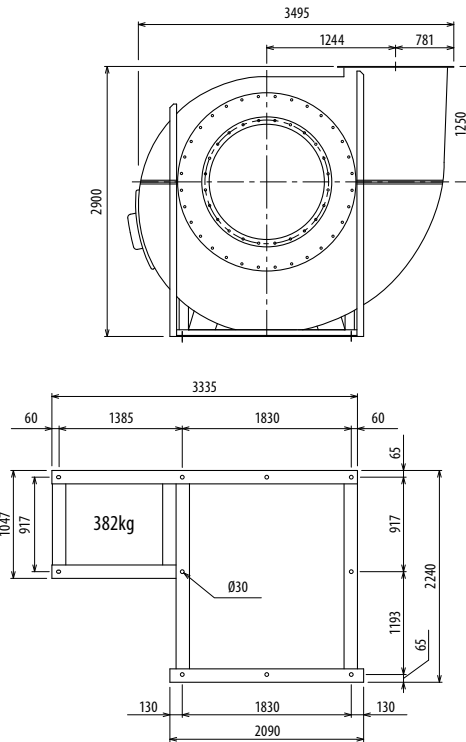
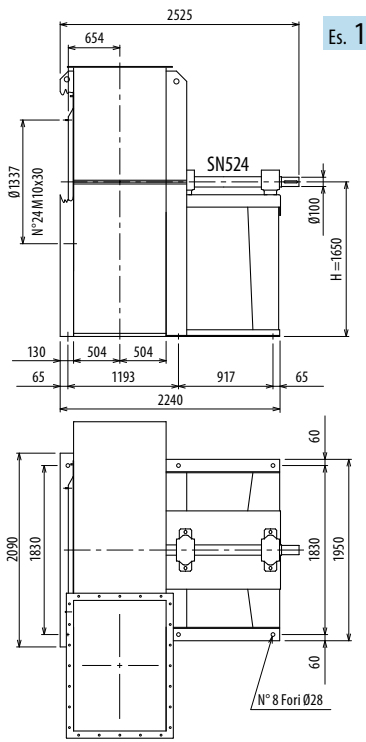

Il ventilatore non è orientabile

■ Le ventilateur n'est pas orientable

■ The fan is not revolvable

■ Der Ventilator ist nicht drehbar

■ El ventilador no es orientable

Ulteriori informazioni e quote:

■ Ulérieures informations et cotes:

■ Further information and sizes:

■ Weitere Infos und Größen:

■ Más informaciones y medidas:

TIPO - Type		PESO Weight	PD ²												
VENTILATORE Fan	MOTORE Motor	Kg	Kgf x m ²	B	I	H	H1	H2	H3	H4	H5	H6			
PRM1250/T		2740	900			1650	1250	2120	1570	1400	1320	1800			

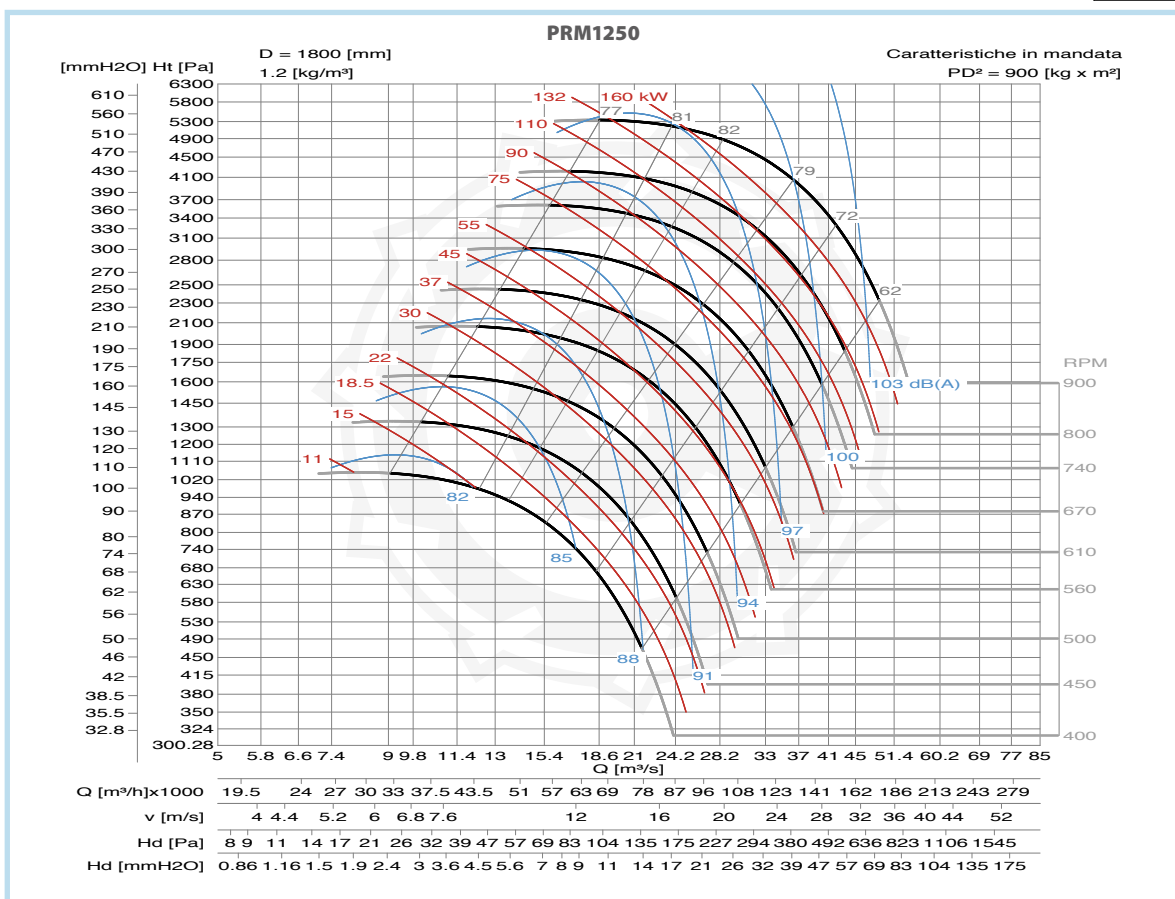
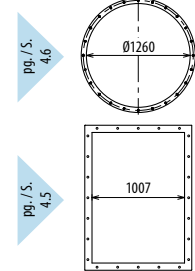

■ DIMENSIONS D'ENCOMBREMENT ET POIDS/COURBES DE FONCTIONNEMENT ■ OVERALL DIMENSIONS AND WEIGHT/WORKING CURVES
■ AUSMARE UND GEWICHTE/FUNKTIONSKURVEN ■ DIMENSIONES QUE OCUPA Y PESOS/CURVAS DE FUNCIONAMIENTO

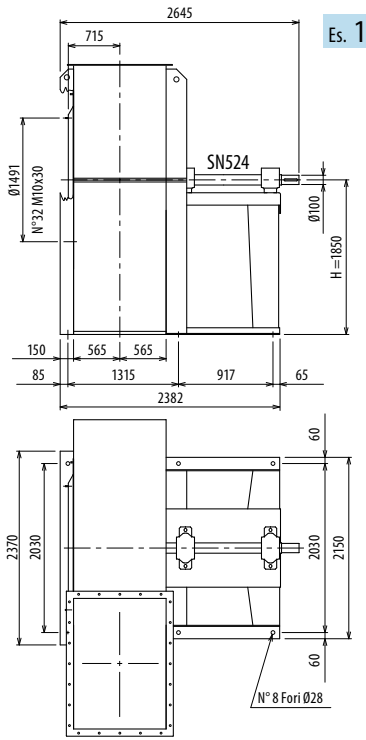

Es. 1

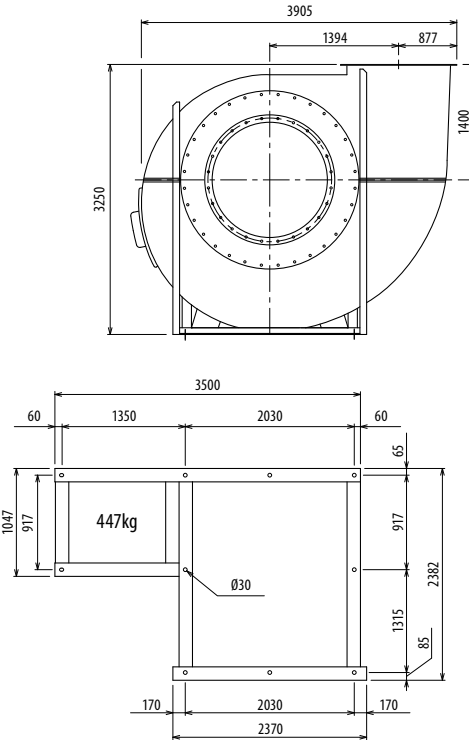

Il ventilatore non è orientabile

■ Le ventilateur n'est pas orientable

■ The fan is not revolvable

■ Der Ventilator ist nicht drehbar

■ El ventilador no es orientable

TIPO - Type		PESO Weight	PD ²													
VENTILATORE Fan	MOTORE Motor	Kg	Kgf x m ²	B	I	H	H1	H2	H3	H4	H5	H6				
PRM1400/T		3630	1400	1850	1400	2360	1750	1600	1450	2000						

Ulteriori informazioni e quote:

- Ulérieures informations et cotes:
- Further information and sizes:
- Weitere Infos und Größen:
- Más informaciones y medidas:

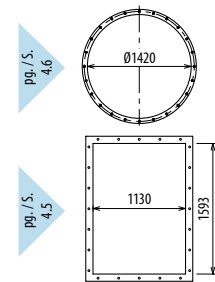

RD0 LG0

RD45 LG45

RD90 LG90

RD135 LG135

RD180 LG180

RD225 LG225

RD270 LG270

RD315 LG315

PRM

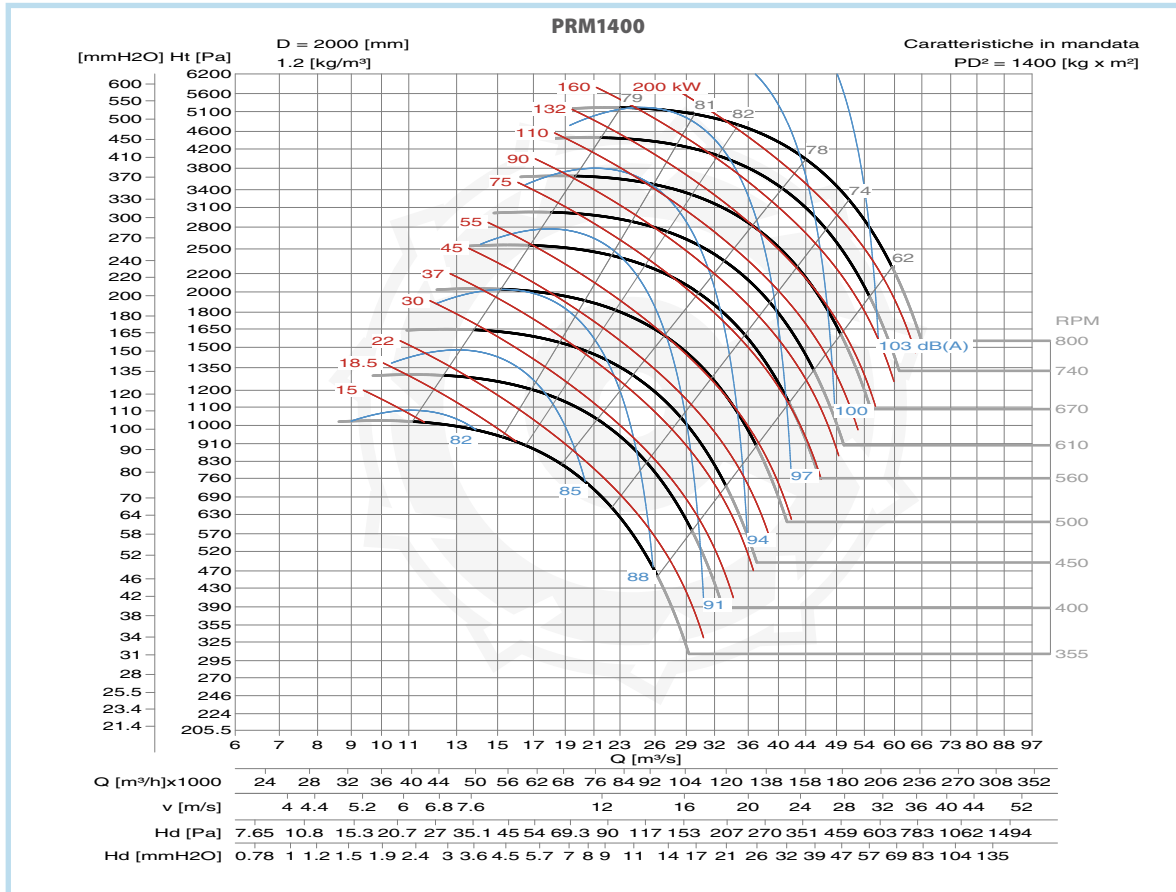

Pagina lasciata intenzionalmente bianca

► Nous avons laissé exprès cette page blanche

► This page is intentionally left blank

► Die Seite wurde absichtlich leer gelassen

► Página dejada en blanco intencionalmente