



■ Features

- Compliance to EN50155 and EN45545-2 railway standard
- Width only 85.5mm
- 2:1 wide input range
- -40~+80°C wide operating temperature
- 150% peak load capability
- Current sharing up to 1920W(3+1)
- DC output adjustable
- Cooling by free air convection
- Can be installed on DIN rail TS-35/7.5 or 15
- Protections: Short circuit / Overload / Over voltage / Over temperature / Input reverse polarity / Input under voltage protection
- 4KVdc I/O isolation(Reinforced isolation)
- DC OK relay contact
- Remote ON-OFF control
- Operating altitude up to 5000 meters(Note.6)
- 3 years warranty

■ Applications

- Bus, tram, metro or railway system
- Industrial control system
- Semi-conductor fabrication equipment
- Factory automation
- Electro-mechanical
- Wireless network
- Telecom or datacom system

■ Description

DDR-480 series is a 480W DIN Rail type DC-DC converter with main features including DIN rail-type easy installation, ultra slim width (85.5mm), 2:1 wide input voltage, fanless design, -40~+80°C wide operating temperature, 4KVdc I/O isolation, 150% peak load, current sharing, DC OK, adjustable output voltage and full protective functions. This series of models has various input options: 16.8~33.6V / 33.6~67.2V / 67.2~154V and multiple output options: 12V / 24V / 48V and can be used for industrial & railway control, security control, communication system and other fields. Suitable applications include to DC buck/boost regulator, increasing system insulation level and voltage drop compensation along cable...etc.

■ Model Encoding

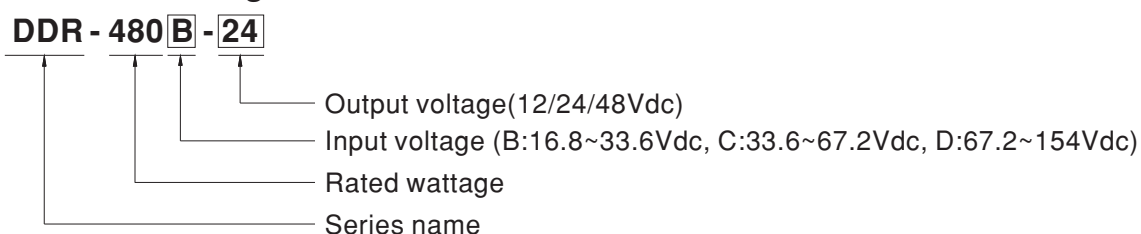



SPECIFICATION

MODEL		DDR-480B-12	DDR-480B-24	DDR-480B-48	DDR-480C-12	DDR-480C-24	DDR-480C-48	DDR-480D-12	DDR-480D-24	DDR-480D-48		
OUTPUT	DC VOLTAGE	12V	24V	48V	12V	24V	48V	12V	24V	48V		
	RATED CURRENT	33.4A	20A	10A	33.4A	20A	10A	33.4A	20A	10A		
	CURRENT RANGE	0 ~ 33.4A	0 ~ 20A	0 ~ 10A	0 ~ 33.4A	0 ~ 20A	0 ~ 10A	0 ~ 33.4A	0 ~ 20A	0 ~ 10A		
	RATED POWER	400.8W	480W	480W	400.8W	480W	480W	400.8W	480W	480W		
	PEAK	CURRENT 5sec.	50.1A	30A	15A	50.1A	30A	15A	50.1A	30A	15A	
		POWER 5sec.	12Vo: 601.2W, 24Vo / 48Vo : 720W									
	RIPPLE & NOISE (max.)	Note.2	100mVp-p	120mVp-p	150mVp-p	100mVp-p	120mVp-p	150mVp-p	100mVp-p	120mVp-p	150mVp-p	
	VOLTAGE ADJ. RANGE		12 ~ 14V	24 ~ 28V	48 ~ 56V	12 ~ 14V	24 ~ 28V	48 ~ 56V	12 ~ 14V	24 ~ 28V	48 ~ 56V	
	VOLTAGE TOLERANCE	Note.3	±1.0%	±1.0%	±1.0%	±1.0%	±1.0%	±1.0%	±1.0%	±1.0%	±1.0%	
	LINE REGULATION		±0.5%	±0.5%	±0.5%	±0.5%	±0.5%	±0.5%	±0.5%	±0.5%	±0.5%	
LOAD REGULATION		±1.0%	±1.0%	±1.0%	±1.0%	±1.0%	±1.0%	±1.0%	±1.0%	±1.0%		
SETUP, RISE TIME		500ms, 60ms										
HOLD UP TIME (Typ.)		Please refer to page 6 hold up time (Load de-rating curve)										
INPUT	VOLTAGE RANGE	CONTINUOUS	16.8 ~ 33.6Vdc			33.6 ~ 67.2Vdc			67.2 ~ 154Vdc			
		Note.4 100ms	14.4 ~ 16.8Vdc			28.8 ~ 33.6Vdc			66 ~ 67.2Vdc			
	EFFICIENCY (Typ.)	90%	91%	90.5%	91%	92%	92%	91%	92%	93%		
	DC CURRENT (Typ.)	23A @24Vdc			11.2A @48Vdc			5A @110Vdc				
	INRUSH CURRENT (Typ.)	30A										
INTERRUPTION OF VOLTAGE SUPPLY		EN50155: 2017-B/C/D type comply with S2 level (10ms)@ full load										
PROTECTION	OVERLOAD	Note.5	Normally works within 150% rated output power for more than 5 seconds and then constant current protection 105~135% rated output power with auto-recovery									
	OVER VOLTAGE		14.4 ~ 17.5V	28.8 ~ 35V	57.6 ~ 65V	14.4 ~ 17.5V	28.8 ~ 35V	57.6 ~ 65V	14.4 ~ 17.5V	28.8 ~ 35V	57.6 ~ 65V	
			Protection type : Shut down o/p voltage, re-power on to recover									
	OVER TEMPERATURE		Shut down o/p voltage, re-power on to recover									
	REVERSE POLARITY		By internal, MOSFET, no damage, recovers automatically after fault condition is removed									
UNDER VOLTAGE LOCKOUT		24Vin (B - type) :Power ON ≥16.8V , OFF ≤16.5V			48Vin (C - type) :Power ON ≥33.6V , OFF ≤33V			110Vin (D - type) :Power ON ≥67.2V , OFF ≤65V				
FUNCTION	DC OK REALY CONTACT RATINGS (max.)	30Vdc/1A resistive load										
	CURRENT SHARING	Up to 1920W (3+1 units). Please refer to the Function Manual										
	REMOTE ON-OFF CONTROL	Please refer to the Function Manual										
ENVIRONMENT	WORKING TEMP.	-40 ~ +80°C (Refer to "Derating Curve")										
	WORKING HUMIDITY	5 ~ 95% RH non-condensing										
	STORAGE TEMP., HUMIDITY	-40 ~ +85, 5 ~ 95% RH non-condensing										
	TEMP. COEFFICIENT	±0.03%/°C (0 ~ 55°C)										
	VIBRATION	Component:10 ~ 500Hz, 5G 10min./1cycle, 60min. each along X, Y, Z axes; Mounting: Compliance to IEC61373										
	OPERATING ALTITUDE	Note.6	5000 meters / OVCII									
SAFETY & EMC (Note 7)	SAFETY STANDARDS	UL 62368-1, IEC 62368-1, AS/NZS 62368-1, EAC TP TC 004 approved										
	WITHSTAND VOLTAGE	I/P-O/P:4KVdc I/P-FG:2.5KVdc O/P-FG:0.71KVdc										
	ISOLATION RESISTANCE	I/P-O/P, I/P-FG, O/P-FG:>100M Ohms / 500Vdc / 25°C / 70% RH										
	EMC EMISSION	Parameter	Standard	EN55032 (CISRP32)			EN55032 (CISRP32)			EN61000-3-3		
			Test Level / Note	Class A			Class B			-----		
			Conducted	EN55032 (CISRP32)			EN55032 (CISRP32)			EN61000-3-3		
			Radiated	EN55032 (CISRP32)			EN55032 (CISRP32)			EN61000-3-3		
			Voltage Flicker	EN61000-3-3			EN61000-3-3			EN61000-3-3		
	EMC IMMUNITY	Parameter	Standard	EN55035			EN61000-4-2			EN61000-4-3		
			Test Level / Note	EN55035			EN61000-4-2			EN61000-4-3		
			ESD	EN55035			EN61000-4-2			EN61000-4-3		
			Radiated	EN55035			EN61000-4-2			EN61000-4-3		
			EFT / Burst	EN55035			EN61000-4-2			EN61000-4-3		
			Surge	EN55035			EN61000-4-2			EN61000-4-3		
			Conducted	EN55035			EN61000-4-2			EN61000-4-3		
Magnetic Field	EN55035			EN61000-4-2			EN61000-4-3					
RAILWAY STANDARD		Compliance to EN45545-2 for fire protection ; Meet EN50155 / IEC60571 including IEC61373 for shock & vibration, EN50121-3-2 for EMC										
OTHERS	MTBF	280.0K hrs min. Telcordia SR-332 (Bellcore) ; 101.7K hrs min. MIL-HDBK-217F (25°C)										
	DIMENSION	85.5*125.2*128.5mm (W*H*D)										
	PACKING	1.375Kg;8pcs/12Kg/0.95CUFT										
NOTE		<p>1. All parameters NOT specially mentioned are measured at normal input (B:24Vdc , C:48Vdc , D:110Vdc) , rated load and 25°C of ambient temperature.</p> <p>2. Ripple & noise are measured at 20MHz of bandwidth by using a 12" twisted pair-wire terminated with a 0.1µf & 47µf parallel capacitor.</p> <p>3. Tolerance : includes set up tolerance, line regulation and load regulation.</p> <p>4. Derating may be needed under low input voltage. Please check the derating curve for more details.</p> <p>5. 150% 5 seconds, please refer to peak loading curves.</p> <p>6. The ambient temperature derating of 3.5°C/1000m with fanless models and of 5°C/1000m with fan models for operating altitude higher than2000m(6500ft).</p> <p>7. The power supply is considered as an independent unit, but the final equipment still need to re-confirm that the whole system complies with the EMC directives. For guidance on how to perform these EMC tests, please refer to "EMI testing of component power supplies." (as available on http://www.meanwell.com)</p>										

■ Block Diagram

fosc : 65KHz

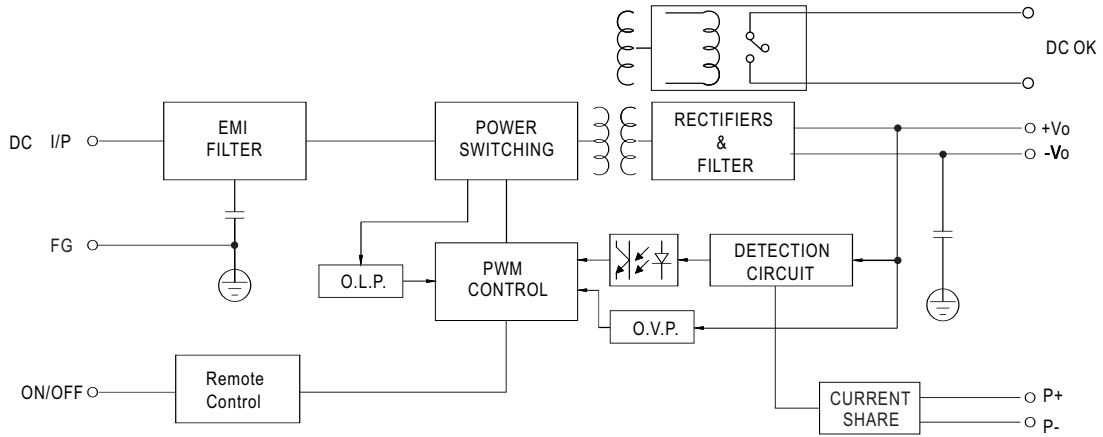

■ Derating Curve

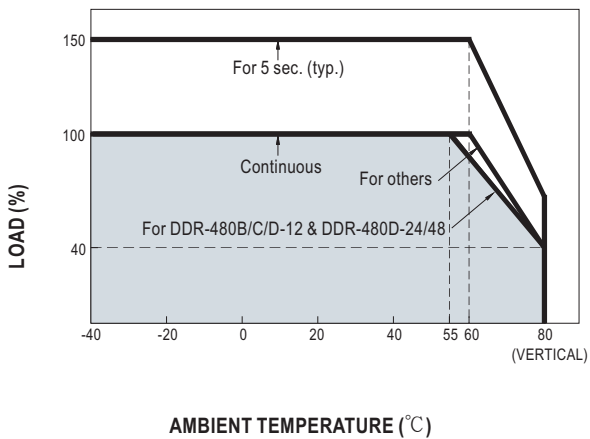

■ Output derating VS Input Voltage

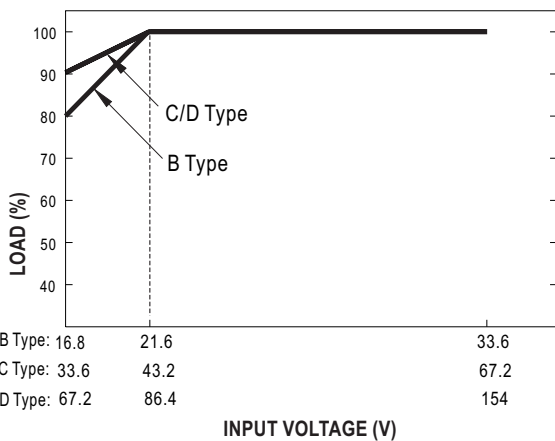

B Type: 16.8	21.6	33.6
C Type: 33.6	43.2	67.2
D Type: 67.2	86.4	154

Peak Loading

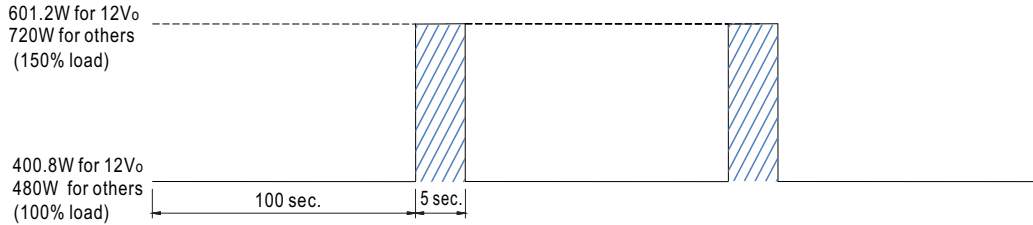

DC OK Relay Contact

Contact Close	PSU turns on / DC OK.
Contact Open	PSU turns off / DC Fail.
Contact Ratings (max.)	30V/1A resistive load.

Function Manual

1. Current sharing

- (1) Parallel operation is available by connecting the units shown as below (P+,P- are connected mutually in parallel) :
- (2) The voltage difference among each output should be minimized that less than 0.2V is required.
- (3) The total output current must not exceed the value determined by the following equation (Output current at parallel operation)

$$= (\text{The rated current per unit}) \times (\text{Number of unit}) \times 0.9.$$
- (4) In parallel operation 4 units is the maximum, please consult the manufacture for other applications.
- (5) When in parallel operation, the minimum output load should be greater than 3% of total output load.

$$(\text{Min. load} > 3\% \text{ rated current per unit} \times \text{number of unit})$$

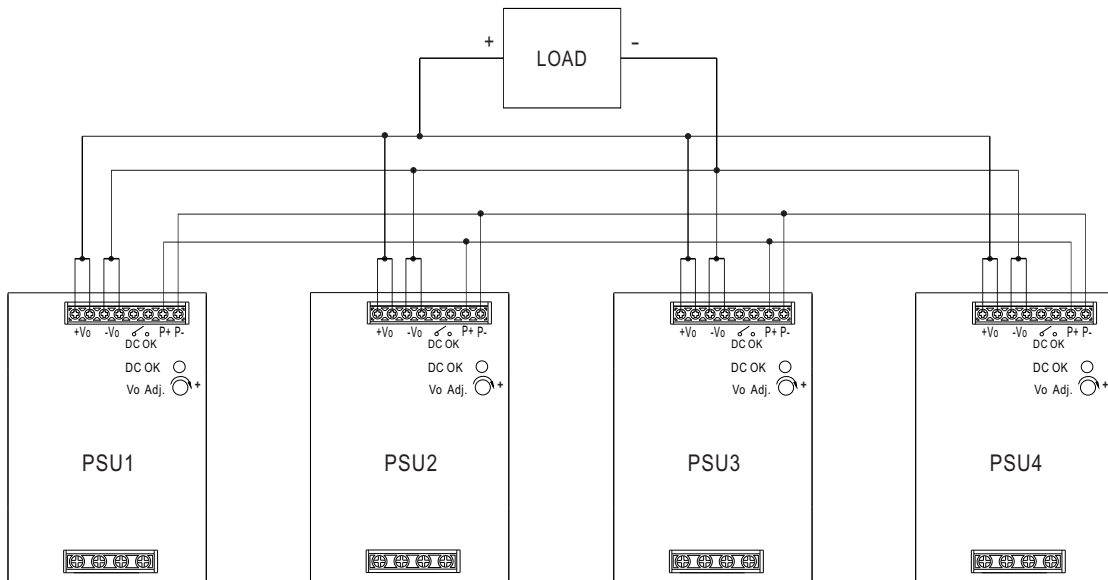

2. Remote ON-OFF Control

※ The power supply can be turned ON-OFF by using the "Remote ON-OFF" function.

Remote ON-OFF (TB1 PIN2,4)	Output Status
Open or 5.5 ~ 10VDC	power supply ON
Short or 0 ~ 0.8VDC	power supply OFF

Input Fuse

There is one fuse connected in series to the positive input line, which is used to protect against abnormal surge. Fuse specifications of each model are shown as below.

Type	Fuse Type	Reference and Rating
B	Time-Lag	Conquer MST, 10A, 250V *5
C	Time-Lag	Conquer MST, 8A, 250V *3
D	Time-Lag	Conquer MST, 6.3A, 250V *2

Input Under-Voltage Protection

If input voltage drops below V_{imin} , the internal control IC shuts down and there is no output voltage. It recovers automatically when input voltage reaches above V_{imin} , please refer to the curve below.

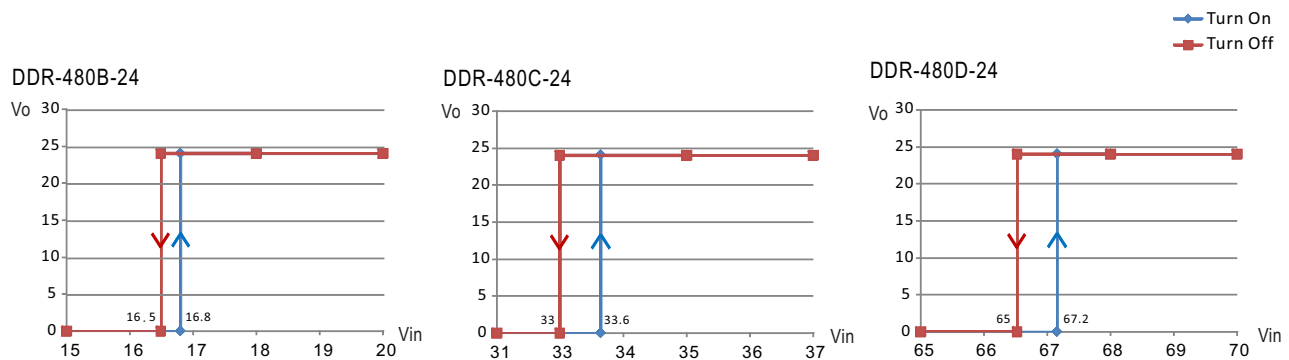

Input Reverse Polarity Protection

There are two MOSFETs connected in series to the negative input line. If the input polarity is connected reversely, the MOSFETs open and there will be no output to protect the unit.

Inrush Current

Inrush current is suppressed by a resistor during the initial start-up, and then the resistor is bypassed by MOSFETs to reduce power consumption after accomplishing the start-up.

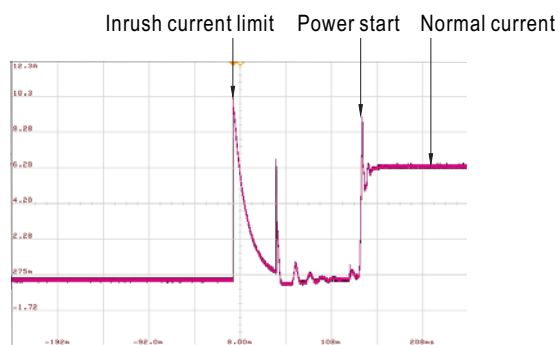

■ Hold-up Time

- EN50155:2017 version- B/C/D type comply with S2 level (10ms) @ full load , please refer to the table and curves show below for the hold up time specification.

Model \ Load	100% load	70% load	other load
B type (24Vin)	10ms min.	16ms min.	figure 1,2,3
C type (48Vin)	11ms min.	17ms min.	figure 4,5,6
D type (110Vin)	16ms min.	24ms min.	figure 7,8,9

DDR-480B-12

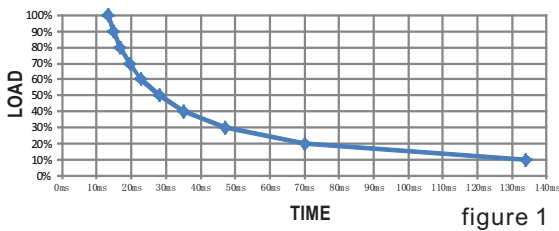

figure 1

DDR-480B-24

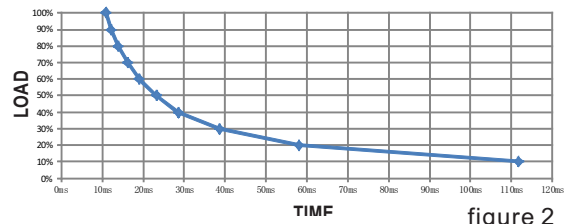

figure 2

DDR-480B-48

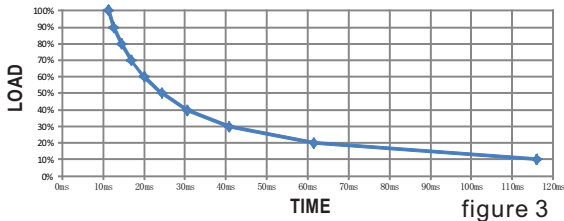

figure 3

DDR-480C-12

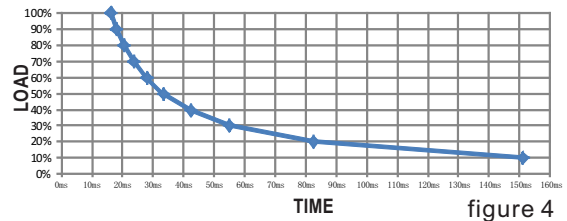

figure 4

DDR-480C-24

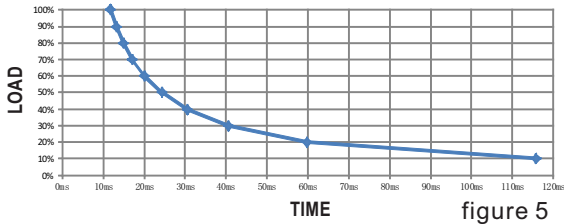

figure 5

DDR-480C-48

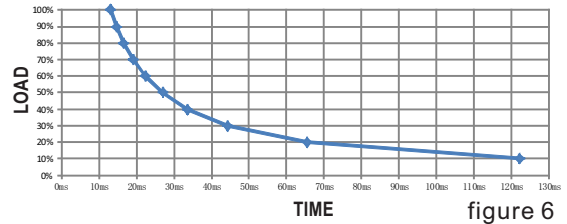

figure 6

DDR-480D-12

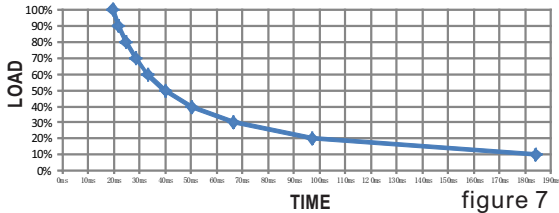

figure 7

DDR-480D-24

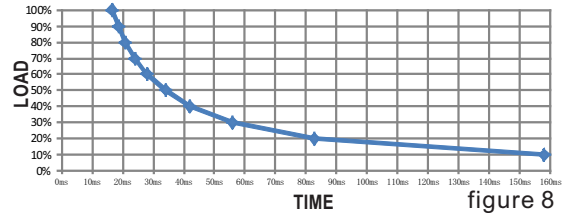

figure 8

DDR-480D-48

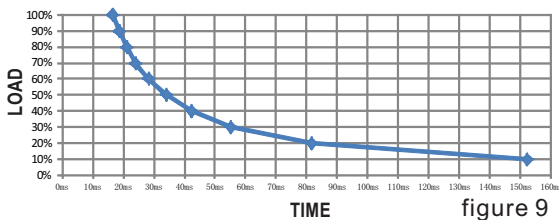
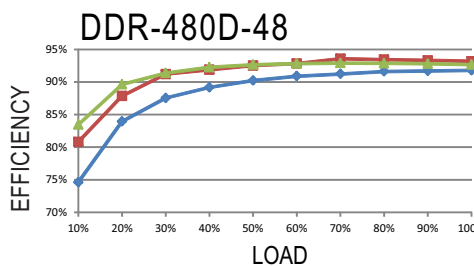
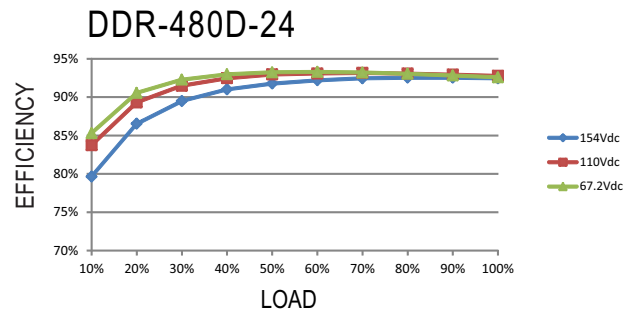
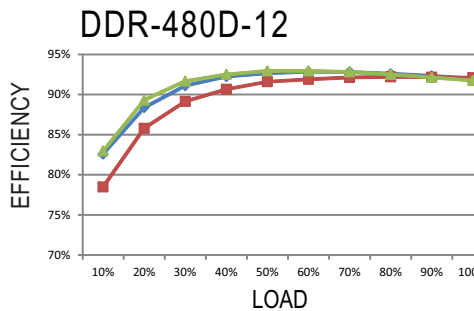
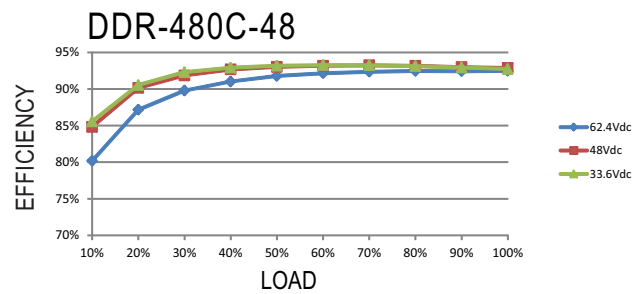
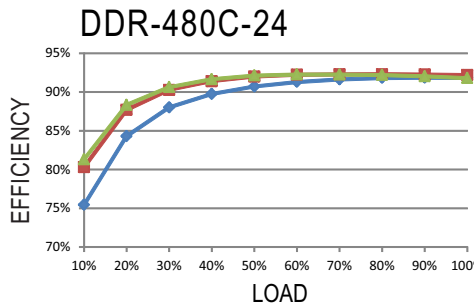
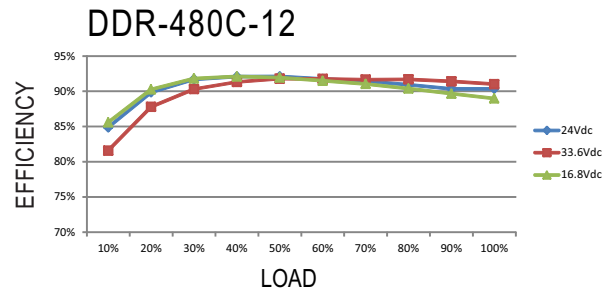
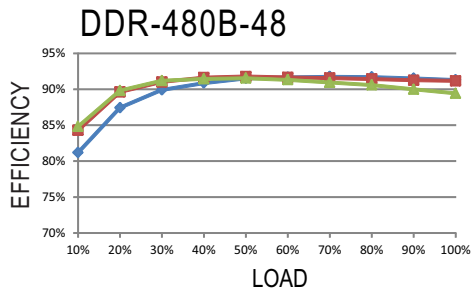
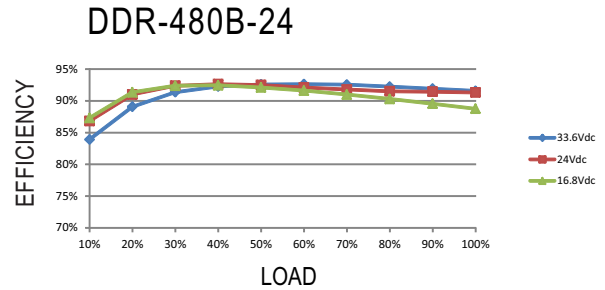
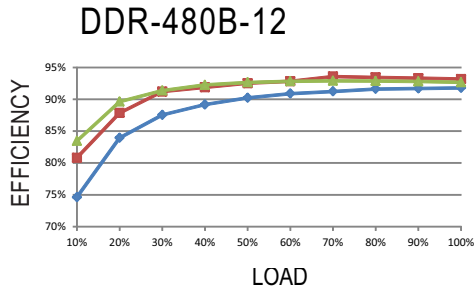

figure 9

■ Efficiency vs Load & Vin Curve

The efficiency vs load & Vin curves of each model are shown as below.



■ Immunity to Environmental Conditions

Test method	Standard	Test conditions	Status
Cooling Test	EN 50155 section 12.2.3 (Column 2, Class TX) EN 60068-2-1	Temperature: -40°C Dwell Time: 2 hrs/cycle	No damage
Dry Heat Test	EN 50155 section 12.2.4 (Column 2, Class TX) EN 50155 section 12.2.4 (Column 3, Class TX & Column 4, Class TX) EN 60068-2-2	Temperature: 70°C / 85°C Duration: 6 hrs / 10min	PASS
Damp Heat Test, Cyclic	EN 50155 section 12.2.5 EN 60068-2-30	Temperature: 25°C~55°C Humidity: 90%~100% RH Duration: 48 hrs	PASS
Vibration Test	EN 50155 section 12.2.11 EN 61373	Temperature: 19°C Humidity: 65% Duration: 10 mins	PASS
Increased Vibration Test	EN 50155 section 12.2.11 EN 61373	Temperature: 19°C Humidity: 65% Duration: 5 hrs	PASS
Shock Test	EN 50155 section 12.2.11 EN 61373	Temperature: 21 ± 3°C Humidity: 65 ± 5% Duration: 30ms*18	PASS
Low Temperature Storage Test	EN 50155 section 12.2.3 (Column 2, Class TX) EN 60068-2-1	Temperature: -40°C Dwell Time: 16 hrs	PASS
Salt Mist Test	EN 50155 section 12.2.10 (Class ST4)	Temperature: 35°C ± 2°C Duration: 48 hrs	PASS

■ EN45545-2 Fire Test Conditions

Test Items			Hazard Level		
	Items	Standard	HL1	HL2	HL3
R22	Oxygen index test	EN 45545-2:2013 EN ISO 4589-2:1996	PASS	PASS	PASS
	Smoke density test	EN 45545-2:2013 EN ISO 5659-2:2006	PASS	PASS	PASS
	Smoke toxicity test	EN 45545-2:2013 NF X70-100:2006	PASS	PASS	PASS
R24	Oxygen index test	EN 45545-2:2013 EN ISO 4589-2:1996	PASS	PASS	PASS
R25	Glow-wire test	EN 45545-2:2013 EN 60695-2-11:2000	PASS	PASS	PASS
R26	Vertical flame test	EN 45545-2:2013 EN 60695-11:2003	PASS	PASS	PASS

Mechanical Specification

Case No. 984F Unit:mm

Terminal Pin No. Assignment (TB2)

Pin No.	Assignment
1,2	DC output +Vo
3,4	DC output -Vo
5,6	DC OK Relay Contact
7,8	P+,P-(Current sharing)

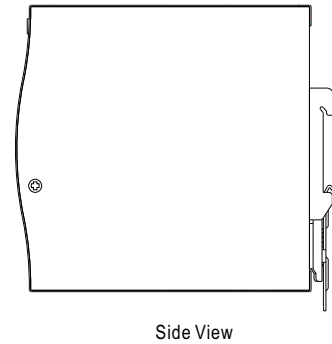
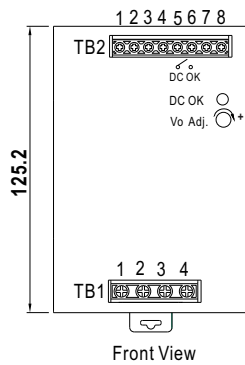
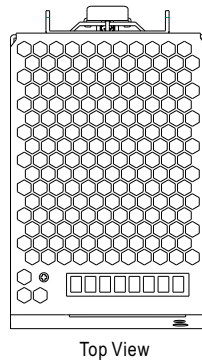
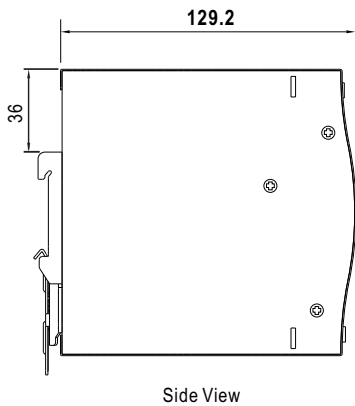

Terminal Pin No. Assignment (TB1)

Pin No.	Assignment
1	FG ⊕
2	DC input -Vin
3	DC input +Vin
4	Remote ON/OFF

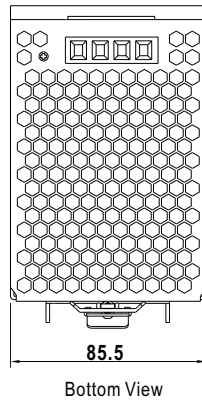

Installation Instruction

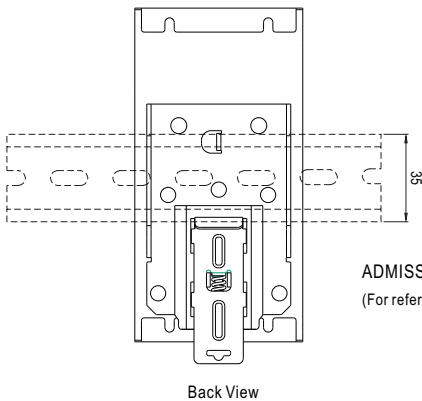

ADMISSIBLE DIN-RAIL: TS35/7.5 OR TS35/15
(For reference only. Not included with unit.)

This series fits DIN rail TS35/7.5 or TS35/15.
For installation details, please refer to the Instruction manual.

Installation Manual

Please refer to : <http://www.meanwell.com/manual.html>